

GRADE  
**2**

# Building Conceptual Understanding and Fluency Through Games

FOR THE COMMON CORE STATE STANDARDS IN MATHEMATICS



# Building Conceptual Understanding and Fluency Through Games

Developing fluency requires a balance and connection between conceptual understanding and computational proficiency. Computational methods that are over-practiced without understanding are forgotten or remembered incorrectly. Conceptual understanding without fluency can inhibit the problem solving process. – NCTM, *Principles and Standards for School Mathematics*, pg. 35

## WHY PLAY GAMES?

People of all ages love to play games. They are fun and motivating. Games provide students with opportunities to explore fundamental number concepts, such as the counting sequence, one-to-one correspondence, and computation strategies. Engaging mathematical games can also encourage students to explore number combinations, place value, patterns, and other important mathematical concepts. Further, they provide opportunities for students to deepen their mathematical understanding and reasoning. Teachers should provide repeated opportunities for students to play games, and let the mathematical ideas emerge as they notice new patterns, relationships, and strategies. Games are an important tool for learning. Here are some advantages for integrating games into elementary mathematics classrooms:

- Playing games encourages strategic mathematical thinking as students find different strategies for solving problems and it deepens their understanding of numbers.
- Games, when played repeatedly, support students' development of computational fluency.
- Games provide opportunities for practice, often without the need for teachers to provide the problems. Teachers can then observe or assess students, or work with individual or small groups of students.
- Games have the potential to develop familiarity with the number system and with "benchmark numbers" – such as 10s, 100s, and 1000s and provide engaging opportunities to practice computation, building a deeper understanding of operations.
- Games provide a school to home connection. Parents can learn about their children's mathematical thinking by playing games with them at home.

## BUILDING FLUENCY

Developing computational fluency is an expectation of the Common Core State Standards. Games provide opportunity for meaningful practice. The research about how students develop fact mastery indicates that drill techniques and timed tests do not have the power that mathematical games and other experiences have. Appropriate mathematical activities are essential building blocks to develop mathematically proficient students who demonstrate computational fluency (Van de Walle & Lovin, *Teaching Student-Centered Mathematics Grades K-3*, pg. 94). Remember, computational fluency includes efficiency, accuracy, and flexibility with strategies (Russell, 2000).

The kinds of experiences teachers provide to their students clearly play a major role in determining the extent and quality of students' learning. Students' understanding can be built by actively engaging in tasks and experiences designed to deepen and connect their knowledge. Procedural fluency and conceptual understanding can be developed through problem solving, reasoning, and argumentation (NCTM, *Principles and Standards for School Mathematics*, pg. 21). Meaningful practice is necessary to develop fluency with basic number combinations and strategies with multi-digit numbers. Practice should be purposeful and should focus on developing thinking strategies and a knowledge of number relationships rather than drill isolated facts (NCTM, *Principles and Standards for School Mathematics*, pg. 87). Do *not* subject any student to computation drills unless the student has developed an efficient strategy for the facts included in the drill (Van de Walle & Lovin, *Teaching Student-Centered Mathematics Grades K-3*, pg. 117). Drill can strengthen strategies with which students feel comfortable – ones they "own" – and will help to make these strategies increasingly automatic. Therefore, drill of strategies will allow students to use them with increased efficiency, even to the point of recalling the fact without being conscious of using a strategy. Drill without an efficient strategy present offers no assistance (Van de Walle & Lovin, *Teaching Student-Centered Mathematics Grades K-3*, pg. 117).

## CAUTIONS

Sometimes teachers use games solely to practice number facts. These games usually do not engage children for long because they are based on students' recall or memorization of facts. Some students are quick to memorize, while others need a few moments to use a related fact to compute. When students are placed in situations in which recall speed determines success, they may infer that being "smart" in mathematics means getting the correct answer quickly instead of valuing the process of thinking. Consequently, students may feel incompetent when they use number patterns or related facts to arrive at a solution and may begin to dislike mathematics because they are not fast enough.

For students to become fluent in arithmetic computation, they must have efficient and accurate methods that are supported by an understanding of numbers and operations. "Standard" algorithms for arithmetic computation are one means of achieving this fluency.

– NCTM, *Principles and Standards for School Mathematics*, pg. 35

Overemphasizing fast fact recall at the expense of problem solving and conceptual experiences gives students a distorted idea of the nature of mathematics and of their ability to do mathematics.

– Seeley, *Faster Isn't Smarter: Messages about Math, Teaching, and Learning in the 21st Century*, pg. 95

Computational fluency refers to having efficient and accurate methods for computing. Students exhibit computational fluency when they demonstrate flexibility in the computational methods they choose, understand and can explain these methods, and produce accurate answers efficiently.

– NCTM, *Principles and Standards for School Mathematics*, pg. 152

Fluency refers to having efficient, accurate, and generalizable methods (algorithms) for computing that are based on well-understood properties and number relationships.

– NCTM, *Principles and Standards for School Mathematics*, pg. 144

### INTRODUCE A GAME

A good way to introduce a game to the class is for the teacher to play the game against the class. After briefly explaining the rules, ask students to make the class's next move. Teachers may also want to model their strategy by talking aloud for students to hear his/her thinking. "I placed my game marker on 6 because that would give me the largest number."

Games are fun and can create a context for developing students' mathematical reasoning. Through playing and analyzing games, students also develop their computational fluency by examining more efficient strategies and discussing relationships among numbers. Teachers can create opportunities for students to explore mathematical ideas by planning questions that prompt students to reflect about their reasoning and make predictions. Remember to always vary or modify the game to meet the needs of your learners. Encourage the use of the Standards for Mathematical Practice.

### HOLDING STUDENTS ACCOUNTABLE

While playing games, have students record mathematical equations or representations of the mathematical tasks. This provides data for students and teachers to revisit to examine their mathematical understanding.

After playing a game, have students reflect on the game by asking them to discuss questions orally or write about them in a mathematics notebook or journal:

1. What skill did you review and practice?
2. What strategies did you use while playing the game?
3. If you were to play the game a second time, what different strategies would you use to be more successful?
4. How could you tweak or modify the game to make it more challenging?

## A Special Thank-You

The development of the NC Department of Public Instruction Document, *Building Conceptual Understanding and Fluency Through Games* was a collaborative effort with a diverse group of dynamic teachers, coaches, administrators, and NCDPI staff. We are very appreciative of all of the time, support, ideas, and suggestions made in an effort to provide North Carolina with quality support materials for elementary level students and teachers. The North Carolina Department of Public Instruction appreciates any suggestions and feedback, which will help improve upon this resource. Please send all correspondence to **Kitty Rutherford** (kitty.rutherford@dpi.nc.gov) or **Denise Schulz** (denise.schulz@dpi.nc.gov)

### GAME DESIGN TEAM

The Game Design Team led the work of creating this support document. With support of their school and district, they volunteered their time and effort to develop *Building Conceptual Understanding and Fluency Through Games*.

**Erin Balga**, Math Coach, Charlotte-Mecklenburg Schools

**Robin Beaman**, First Grade Teacher, Lenoir County

**Emily Brown**, Math Coach, Thomasville City Schools

**Leanne Barefoot Daughtry**, District Office, Johnston County

**Ryan Dougherty**, District Office, Union County

**Paula Gambill**, First Grade Teacher, Hickory City Schools

**Tami Harsh**, Fifth Grade teacher, Currituck County

**Patty Jordan**, Instructional Resource Teacher, Wake County

**Tania Rollins**, Math Coach, Ashe County

**Natasha Rubin**, Fifth Grade Teacher, Vance County

**Dorothie Willson**, Kindergarten Teacher, Jackson County

**Kitty Rutherford**, NCDPI Elementary Consultant

**Denise Schulz**, NCDPI Elementary Consultant

**Allison Eargle**, NCDPI Graphic Designer

**Renée E. McHugh**, NCDPI Graphic Designer

# Second Grade – Standards

- 1. Extending understanding of base-ten notation** – Students extend their understanding of the base-ten system. This includes ideas of counting in fives, tens, and multiples of hundreds, tens, and ones, as well as number relationships involving these units, including comparing. Students understand multi-digit numbers (up to 1000) written in base-ten notation, recognizing that the digits in each place represent amounts of thousands, hundreds, tens, or ones (e.g., 853 is 8 hundreds + 5 tens + 3 ones).
- 2. Building fluency with addition and subtraction** – Students use their understanding of addition to develop fluency with addition and subtraction within 100. They solve problems within 1000 by applying their understanding of models for addition and subtraction, and they develop, discuss, and use efficient, accurate, and generalizable methods to compute sums and differences of whole numbers in base-ten notation, using their understanding of place value and the properties of operations. They select and accurately apply methods that are appropriate for the context and the numbers involved to mentally calculate sums and differences for numbers with only tens or only hundreds.
- 3. Using standard units of measure** – Students recognize the need for standard units of measure (centimeter and inch) and they use rulers and other measurement tools with the understanding that linear measure

involves iteration of units. They recognize that the smaller the unit, the more iterations they need to cover a given length.

- 4. Describing and analyzing shapes** – Students describe and analyze shapes by examining their sides and angles. Students investigate, describe, and reason about decomposing and combining shapes to make other shapes. Through building, drawing, and analyzing two- and three-dimensional shapes, students develop a foundation for understanding attributes of two- and three-dimensional shapes, students develop a foundation for understanding area, volume, congruence, similarity, and symmetry in later grades.

## **MATHEMATICAL PRACTICES**

- 1. Make sense of problems and persevere in solving them.**
- 2. Reason abstractly and quantitatively.**
- 3. Construct viable arguments and critique the reasoning of others.**
- 4. Model with mathematics.**
- 5. Use appropriate tools strategically.**
- 6. Attend to precision.**
- 7. Look for and make use of structure.**
- 8. Look for and express regularity in repeated reasoning.**

## **OPERATIONS AND ALGEBRAIC THINKING**

### **Represent and solve problems involving addition and subtraction.**

- 2.OA.1** Use addition and subtraction within 100 to solve one- and two-step word problems involving situations of adding to, taking from, putting together, taking apart, and comparing, with unknowns in all positions, e.g., by using drawings and equations with a symbol for the unknown number to represent the problem. (Note: See Glossary, Table 1.)

### **Add and subtract within 20.**

- 2.OA.2** Fluently add and subtract within 20 using mental strategies. (Note: See standard 1.OA.6 for a list of mental strategies). By end of Grade 2, know from memory all sums of two one-digit numbers.

### **Work with equal groups of objects to gain foundations for multiplication.**

- 2.OA.3** Determine whether a group of objects (up to 20) has an odd or even number of members, e.g., by pairing objects or counting them by 2s; write an equation to express an even number as a sum of two equal addends.
- 2.OA.4** Use addition to find the total number of objects arranged in rectangular arrays with up to 5 rows and up to 5 columns; write an equation to express the total as a sum of equal addends.

## **NUMBER AND OPERATIONS IN BASE TEN**

### **Understand place value.**

- 2.NBT.1** Understand that the three digits of a three-digit number represent amounts of hundreds, tens, and ones; e.g., 706 equals 7 hundreds, 0 tens, and 6 ones. Understand the following as special cases:
- 100 can be thought of as a bundle of ten tens – called a “hundred.”
  - The numbers 100, 200, 300, 400, 500, 600, 700, 800, 900 refer to one, two, three, four, five, six, seven, eight, or nine hundreds (and 0 tens and 0 ones).
- 2.NBT.2** Count within 1000; skip-count by 5s, 10s, and 100s.
- 2.NBT.3** Read and write numbers to 1000 using base-ten numerals, number names, and expanded form.
- 2.NBT.4** Compare two three-digit numbers based on meanings of the hundreds, tens, and ones digits, using  $>$ ,  $=$ , and  $<$  symbols to record the results of comparisons.

### **Use place value understanding and properties of operations to add and subtract.**

- 2.NBT.5** Fluently add and subtract within 100 using strategies based on place value, properties of operations, and/or the relationship between addition and subtraction.
- 2.NBT.6** Add up to four two-digit numbers using strategies based on place value and properties of operations.
- 2.NBT.7** Add and subtract within 1000, using concrete models or drawings and strategies based on place value, properties of operations, and/or the relationship between addition and subtraction; relate the strategy to a written method. Understand that in adding or subtracting three-digit numbers, one adds or subtracts hundreds and hundreds, tens and tens, ones and ones; and sometimes it is necessary to compose or decompose tens or hundreds.
- 2.NBT.8** Mentally add 10 or 100 to a given number 100-900, and mentally subtract 10 or 100 from a given number 100-900.
- 2.NBT.9** Explain why addition and subtraction strategies work, using place value and the properties of operations. (Note: Explanations may be supported by drawings or objects.)

## **MEASUREMENT AND DATA**

### **Measure and estimate lengths in standard units.**

- 2.MD.1** Measure the length of an object by selecting and using appropriate tools such as rulers, yardsticks, meter sticks, and measuring tapes.
- 2.MD.2** Measure the length of an object twice, using length units of different lengths for the two measurements; describe how the two measurements relate to the size of the unit chosen.
- 2.MD.3** Estimate lengths using units of inches, feet, centimeters, and meters.
- 2.MD.4** Measure to determine how much longer one object is than another, expressing the length difference in terms of a standard length unit.

### **Relate addition and subtraction to length.**

- 2.MD.5** Use addition and subtraction within 100 to solve word problems involving lengths that are given in the same units, e.g., by using drawings (such as drawings of rulers) and equations with a symbol for the unknown number to represent the problem.
- 2.MD.6** Represent whole numbers as lengths from 0 on a number line diagram with equally spaced points corresponding to the numbers 0, 1, 2, ..., and represent whole-number sums and differences within 100 on a number line diagram.

**Work with time and money.**

- 2.MD.7** Tell and write time from analog and digital clocks to the nearest five minutes, using a.m. and p.m.
- 2.MD.8** Solve word problems involving dollar bills, quarters, dimes, nickels, and pennies, using \$ and ¢ symbols appropriately. *Example: If you have 2 dimes and 3 pennies, how many cents do you have?*

**Represent and interpret data.**

- 2.MD.9** Generate measurement data by measuring lengths of several objects to the nearest whole unit, or by making repeated measurements of the same object. Show the measurements by making a line plot, where the horizontal scale is marked off in whole-number units.
- 2.MD.10** Draw a picture graph and a bar graph (with single-unit scale) to represent a data set with up to four categories. Solve simple put together, take-apart, and compare problems using information presented in a bar graph. (Note: See Glossary, Table 1.)

**GEOMETRY****Reason with shapes and their attributes.**

- 2.G.1** Recognize and draw shapes having specified attributes, such as a given number of angles or a given number of equal faces. (Note: Sizes are compared directly or visually, not compared by measuring.) Identify triangles, quadrilaterals, pentagons, hexagons, and cubes.
- 2.G.2** Partition a rectangle into rows and columns of same-size squares and count to find the total number of them.
- 2.G.3** Partition circles and rectangles into two, three, or four equal shares, describe the shares using the words *halves*, *thirds*, *half of*, *a third of*, etc., and describe the whole as two halves, three thirds, four fourths. Recognize that equal shares of identical wholes need not have the same shape.

# Table of Contents

## Operations and Algebraic Thinking

Domino Derby.....	2.OA.2.....	.2
Going Fishing.....	2.OA.2.....	.3
Take Ten.....	2.OA.2.....	.4
Easy as Pie.....	2.OA.2; 2.NBT.5.....	.8
Double Six Dominos.....	2.OA.2.....	.11
Watch Out, Addition.....	2.OA.2.....	.12
Picking Grapes.....	2.OA.2.....	.14
Mooove It Subtraction.....	2.OA.2.....	.17
Road Rally.....	2.OA.2; 2.NBT.5.....	.19
Space Chase.....	2.OA.2.....	.33
Robot Races.....	2.OA.2.....	.34
Numberville.....	2.OA.2; 2.OA.3.....	.35
Odds and Evens.....	2.OA.2; 2.OA.3.....	.39
Spin An Array.....	2.OA.4.....	.40

## Number and Operations in Base Ten

Closest to 1000.....	2.NBT.1.....	.42
Hopping to 1000.....	2.NBT.2.....	.44
Out Number Your Neighbor.....	2.NBT.1; 2.NBT.4.....	.52
Number Concentration.....	2.NBT.3.....	.55
Greater Gators.....	2.NBT.4; 2.NBT.6.....	.58
Easy as Pie.....	2.OA.2; 2.NBT.5.....	.8
Road Rally.....	2.OA.2; 2.NBT.5.....	.19
Target 1000.....	2.NBT.7; 2.NBT.8.....	.60
Target 0.....	2.NBT.7; 2.NBT.8.....	.64

## Measurement and Data

Centimeter Maze.....	2.MD.1.....	.68
Roll for the Gold.....	2.MD.1.....	.69
Time Concentration.....	2.MD.7.....	.70

## Geometry

Geometry Concentration.....	2.G.1.....	.72
Banana Splits.....	2.G.2.....	.73

# Domino Derby

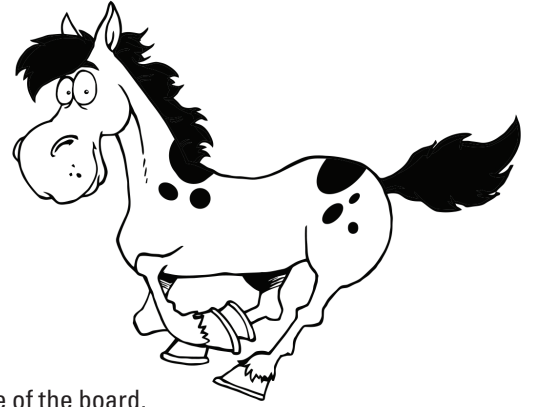

**Building Fluency:** adding within 20

**Materials:** gameboard, set of dominoes, paper, pencil

**Number of Players:** 2

**Directions:**

1. Place dominoes face down on the table.
2. Players take turns drawing a domino.
3. Add the sum of the dots on the domino.
4. If it matches the player's side of the game board, the player places in on their side of the board.  
If the sum equals six, the player loses their turn.
5. The first player to fill their side of the gameboard wins.

**Variation/Extension:** Each player should write a number sentence to explain why the domino does or does not fit (eg.  $2 + 3 = 5$ ;  $5 < 6$ )

**PLAYER 1: Less than six**

**PLAYER 2: More than six**

# Going Fishing

**Building Fluency:** adding within 20

**Materials:** gameboard, pair of dice, 8 markers for each player

**Number of Players:** 2-3

**Directions:**

1. Players take turn rolling the dice.
2. Roll the dice and add the numbers. Place a colored marker on the sum. If there are no places available for that sum, the player loses their turn.
3. The winner will be the first player to get eight markers on the board.

**Variation/Extension:** Use playing cards and remove all face cards. Aces equal 1. Use number cards 1-10.

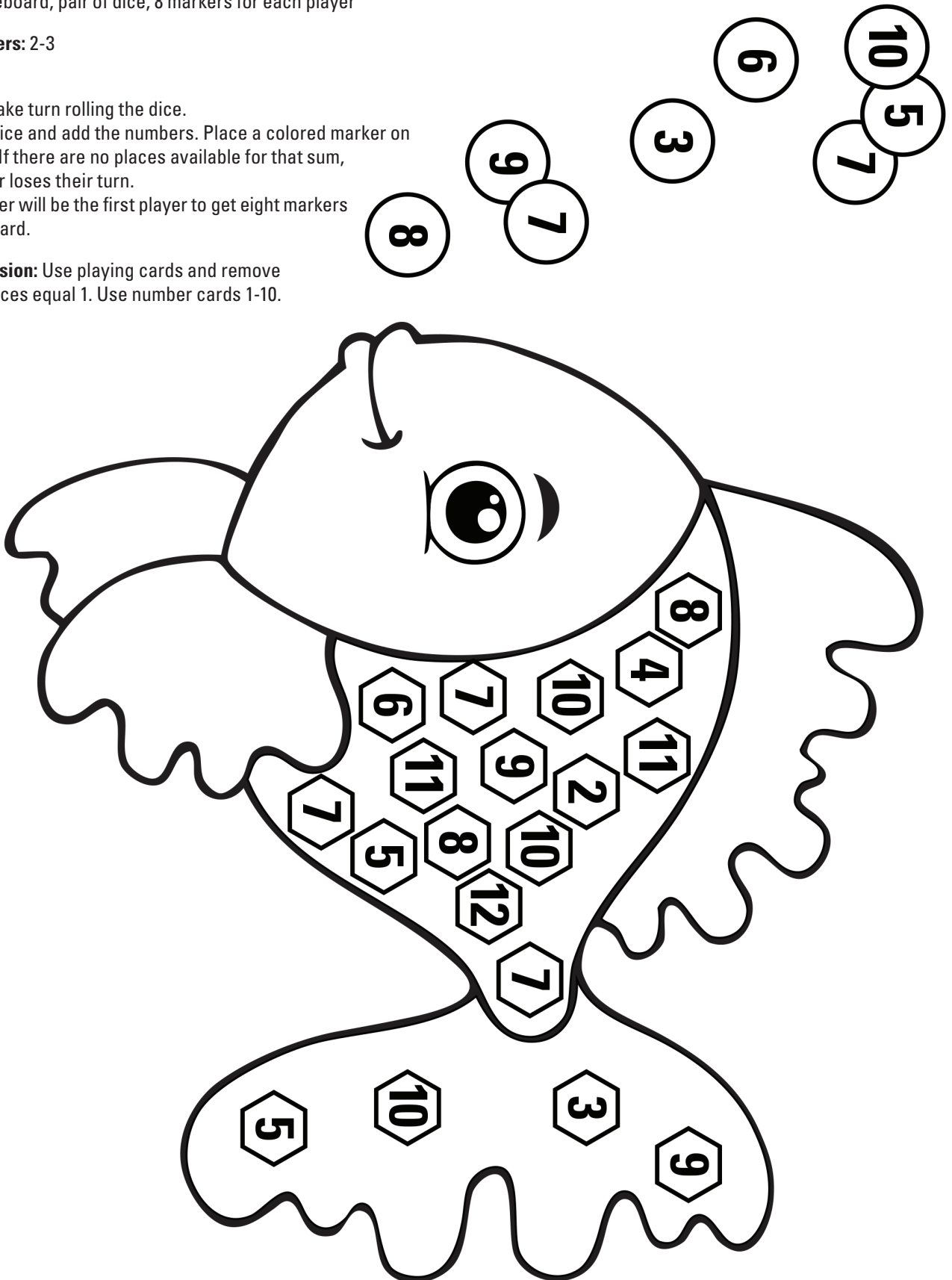



# Take Ten

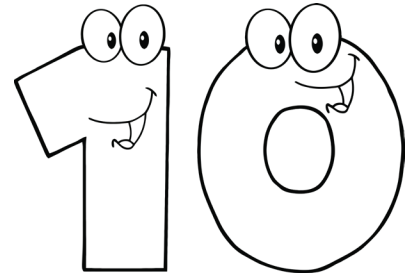

**Building Fluency:** adding within 20

**Materials:** game board and four sets of 0-10 number cards

**Number of Players:** 2

**Directions:**

1. Shuffle the number cards and place them face up on the gameboard below (four rows and three columns).
2. Player 1 looks for all the combinations of two cards that add up to 10. Remove those cards from the board.
3. Player 1 may continue as long as there are cards that add up to 10 on the board.
4. At the end of Player 1's turn, fill the empty spaces on the game board with cards from the deck.
5. Player 2 begins their turn.
6. The winner is the player with the most cards.

**Variation/Extension:** Instead of looking for sums of 10, students can look for various sums (eg. sums of 15, sums greater than 15)

**0**

**1**

**2**

**3**

**4**

**5**

**6**

**7**

**8**

**9**

**10**

**0**

**1**

**2**

**3**

**4****5****6****7****8****9****10****0****1****2****3****4****5****6****7**

**8****9****10****0****1****2****3****4****5****6****7****8****9****10**

# Easy as Pie

**Building Fluency:** adding and subtracting within 20 and 100

**Materials:** gameboard, ten game markers for each player, paper

**Number of Players:** 2-4

**Directions:**

1. Identify the "Target Sum."
2. The first player places one of their markers on any number on the gameboard and says the number aloud.
3. The next player places one of their markers on any number and mentally adds it to the previous number and says the sum aloud.
4. Each player follows in turn by placing one of their markers on another number and mentally adding it to the previous sum and saying the new sum aloud.
5. The winner is the first player to reach the "target sum."

**Variation/Extension:** Players could begin with a target number and then subtract the numbers on which they place their markers. The winner would be the first player to reach zero. Players could change the target number. Players could use number lines or hundreds boards as a tool or add mentally.

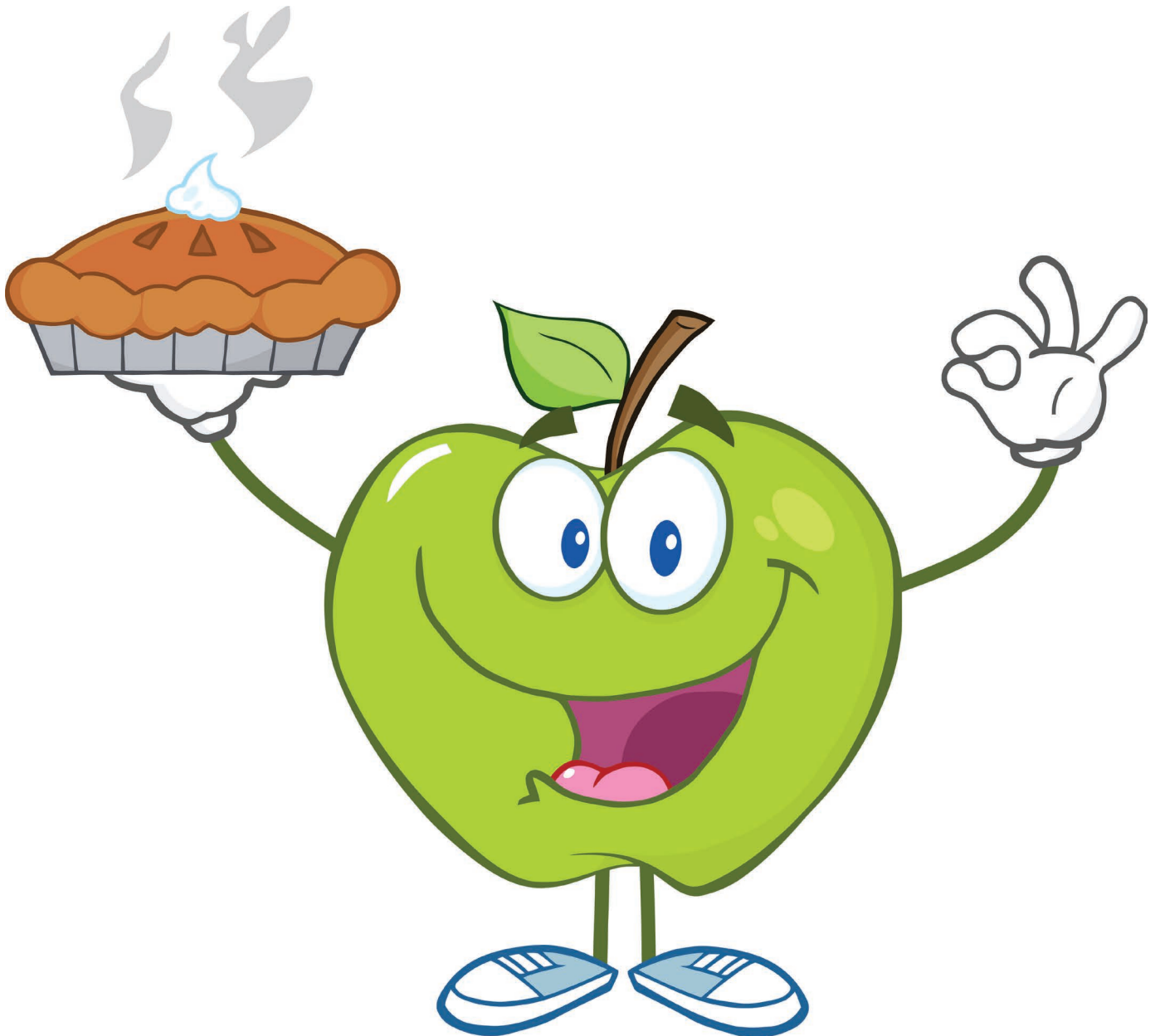

Target: 20

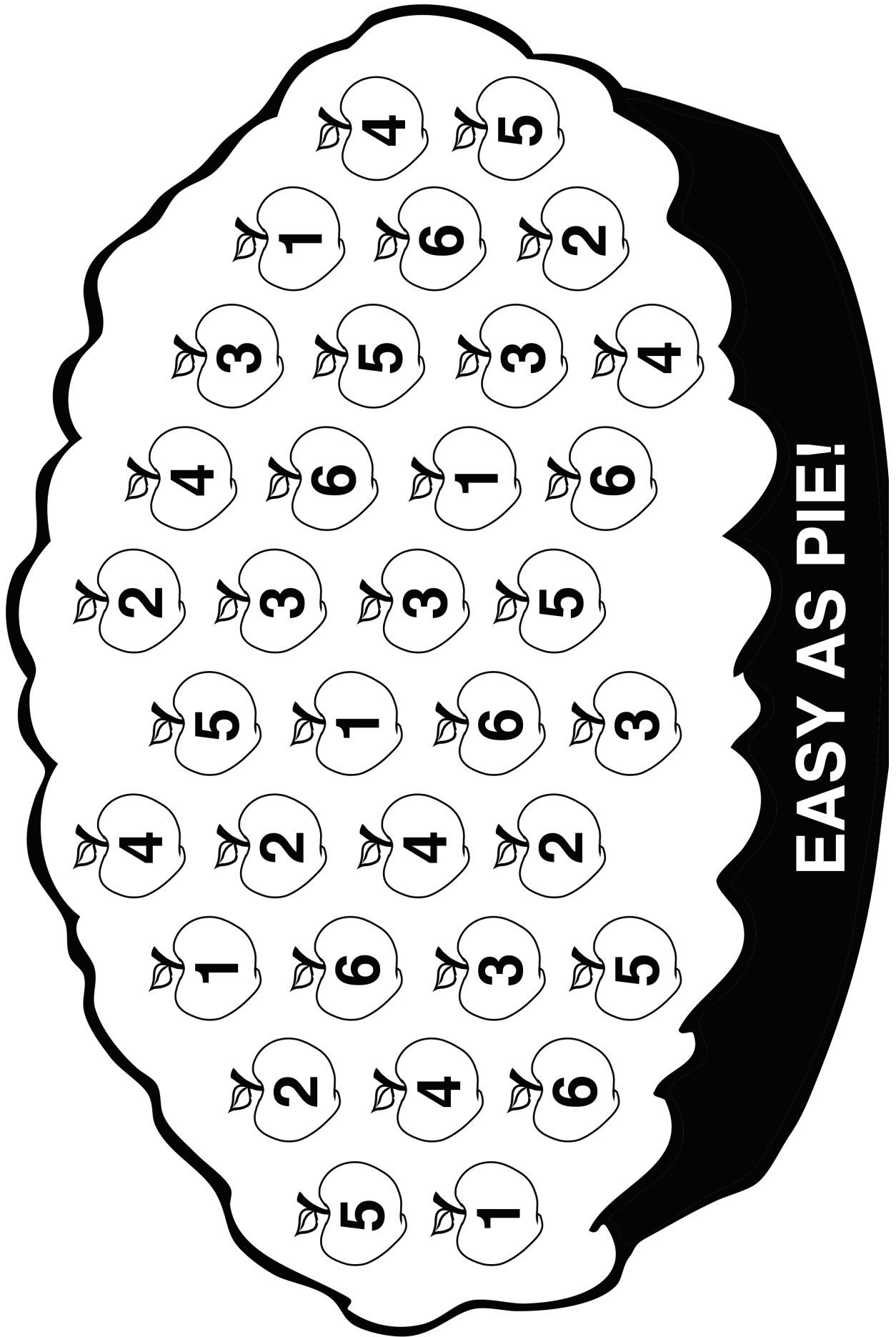

**EASY AS PIE!**

Target: 100



EASY AS PIE!

# Double Six Dominos

**Building Fluency:** adding within 20

**Materials:** gameboard, set of dominos (different color sets if possible)

**Number of Players:** 2-3

**Directions:**

1. Place dominoes face down on the table.
2. Players take turns drawing a domino.
3. Add the sum of the dots on the domino. If it matches a sum on the gameboard, place the domino on the board. If there is no matching sum, the player loses their turn.
4. Players should keep a tally chart of the number of dominoes they place on the board if dominoe sets are not different colors.
5. The winner is the player with the most dominoes on the board.

**Variation/Extension:** Use dice instead of dominoes. Students roll two die on each turn. Students can write equations in their math notebooks.

7	10	2	9	11	3	12
0	6	10	5	3	8	4
1	6	10	9	7	12	



## Watch Out, Addition

**Building Fluency:** adding within 20

**Materials:** gameboard, pair of dice, different color game markers for each player

**Number of Players:** 2-3

**Directions:**

1. Player 1 rolls a pair of dice and adds the numbers together. They cover the sum with a colored marker.
2. Player 2 rolls and finds the sum. If another player's marker is already on the sum, they can remove and replace it.
3. The winner is the first player to get six markers in a row.

**Variation/Extension:** There is an additional game board with larger numbers. Players can use number cards 0-9 and draw two cards or create their own gameboard.



9	7	12	9	4	6
8	2	5	11	3	12
4	7	8	3	11	8
6	10	5	10	6	5
7	4	9	2	7	10
7	2	10	9	12	11

## Watch Out, Addition

<b>18</b>	<b>14</b>	<b>12</b>	<b>4</b>	<b>6</b>	<b>3</b>
<b>16</b>	<b>4</b>	<b>10</b>	<b>11</b>	<b>9</b>	<b>12</b>
<b>4</b>	<b>7</b>	<b>8</b>	<b>3</b>	<b>11</b>	<b>8</b>
<b>6</b>	<b>10</b>	<b>5</b>	<b>10</b>	<b>6</b>	<b>5</b>
<b>14</b>	<b>8</b>	<b>18</b>	<b>4</b>	<b>7</b>	<b>10</b>
<b>3</b>	<b>7</b>	<b>11</b>	<b>9</b>	<b>12</b>	<b>15</b>

# Picking Grapes

**Building Fluency:** subtracting within 20

**Materials:** gameboard, one die, game markers

**Number of Players:** 2

**Directions:**

1. Players take turns rolling the die and subtracting the number on the die from 10.
2. Cover the difference on your bunch of grapes.
3. The winner is the person that covers all of their grapes first.

**Variation/Extension:** Use an additional game board with larger numbers and subtract from 20. You could vary using one or two dice. Students could create their own Picking Grapes gameboard.

**PLAYER 1**

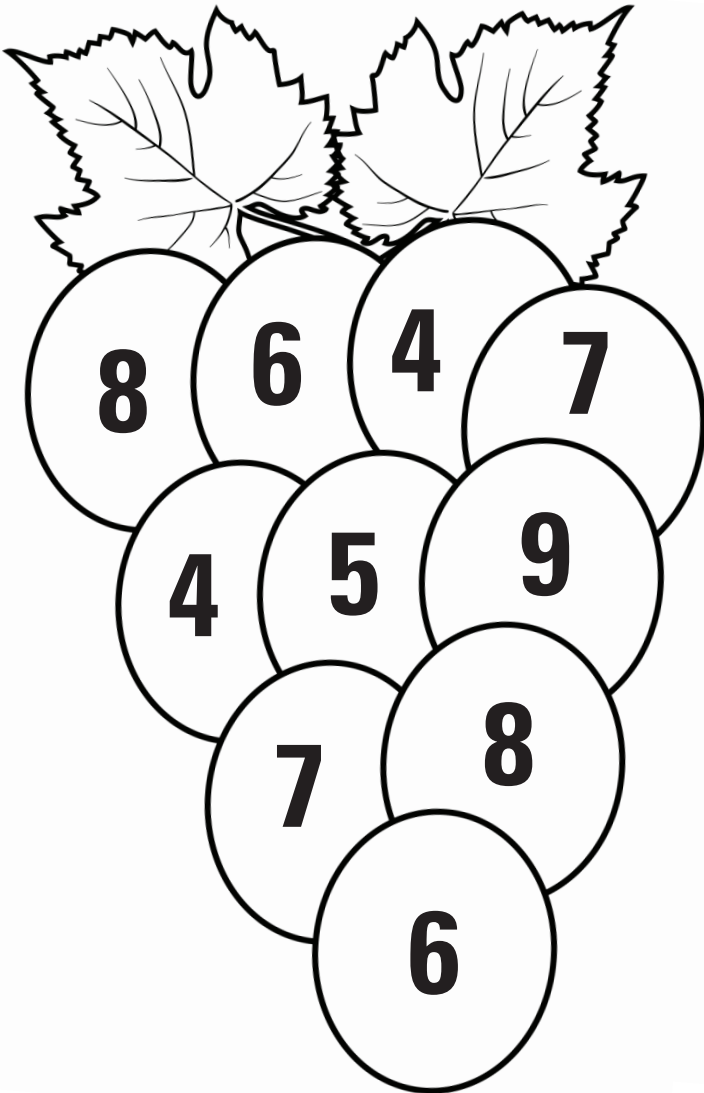

**PLAYER 2**

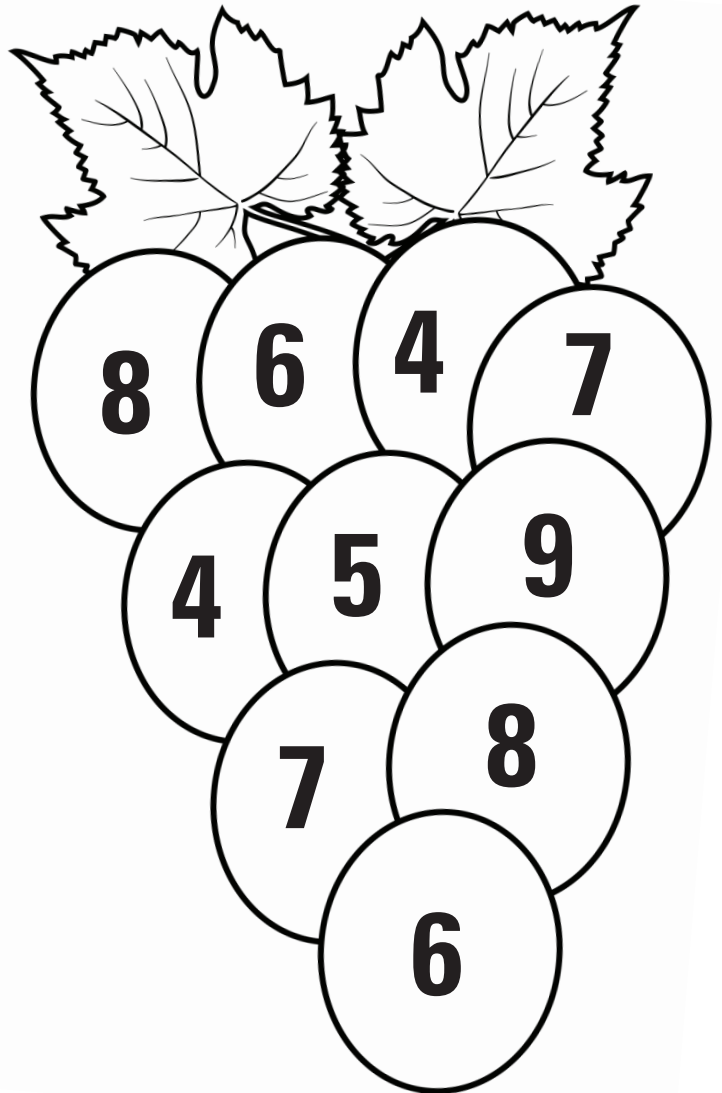

# Picking Grapes

**PLAYER 1**

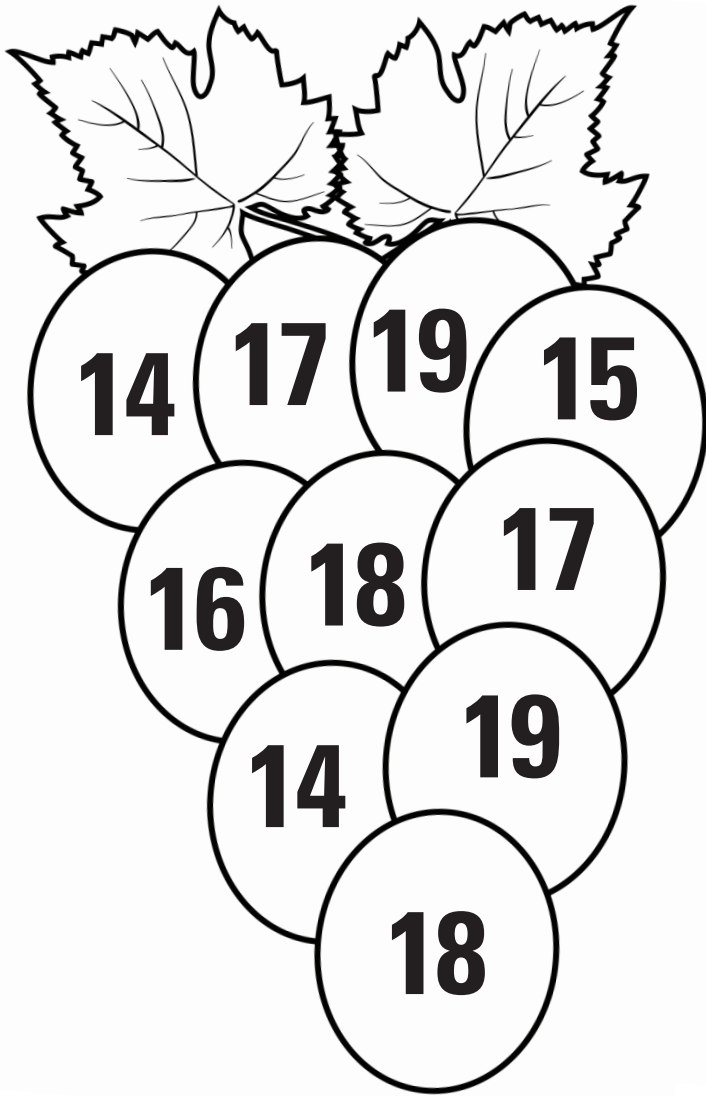

**PLAYER 2**

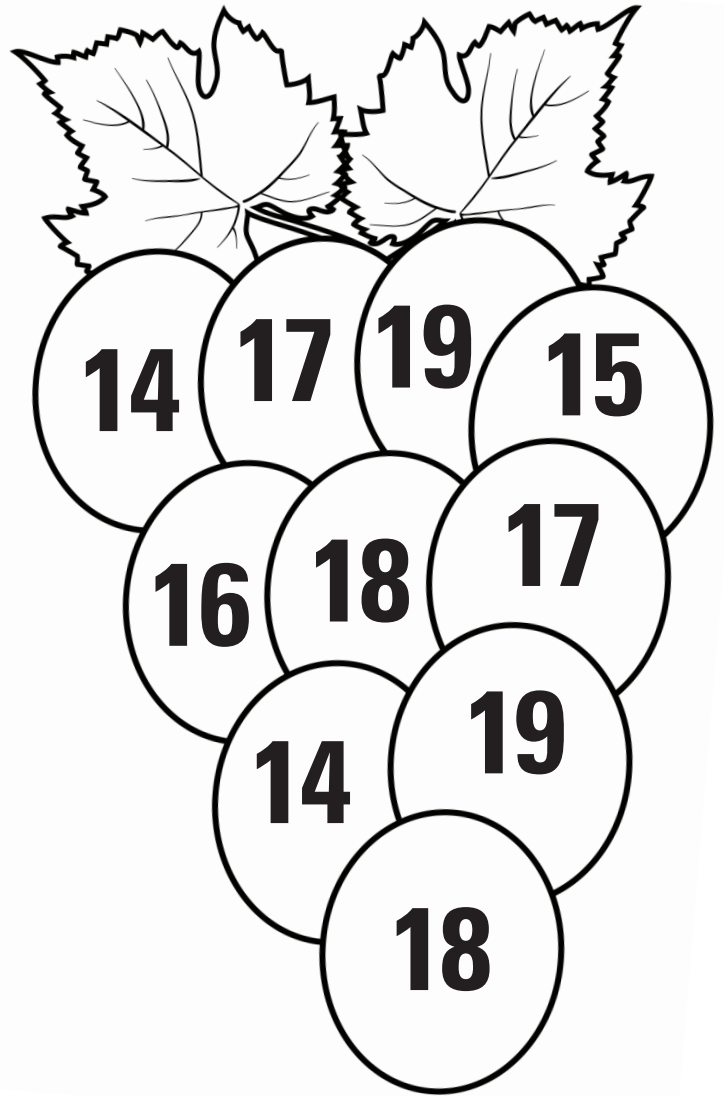

# Picking Grapes

**PLAYER 1**

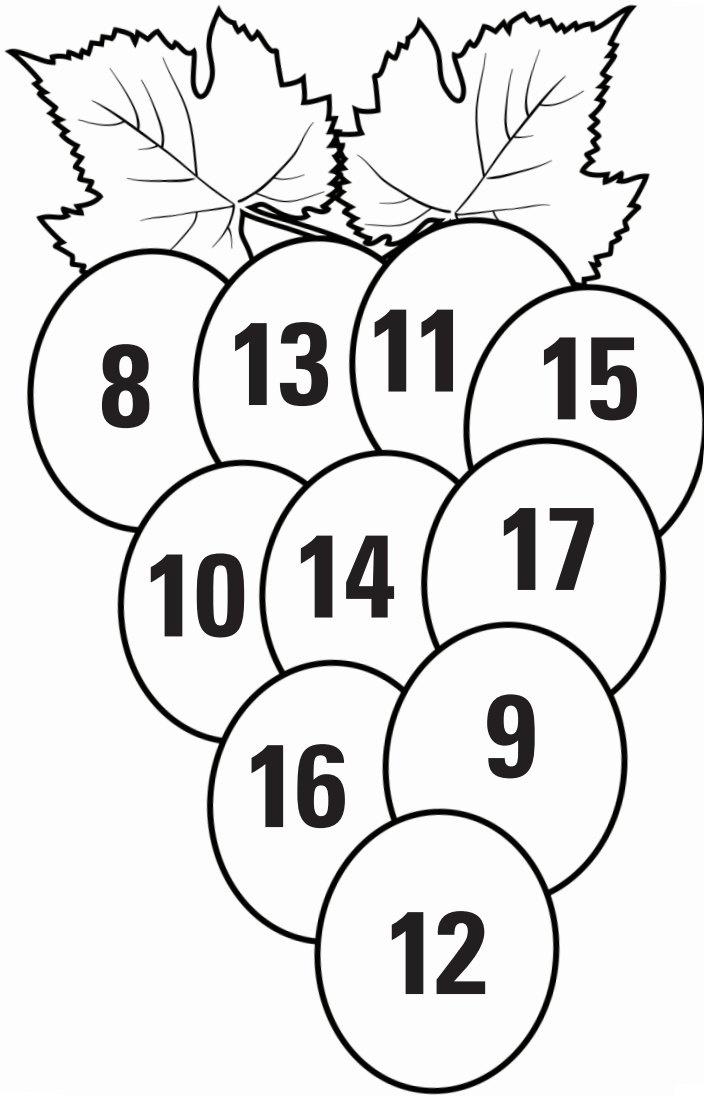

**PLAYER 2**

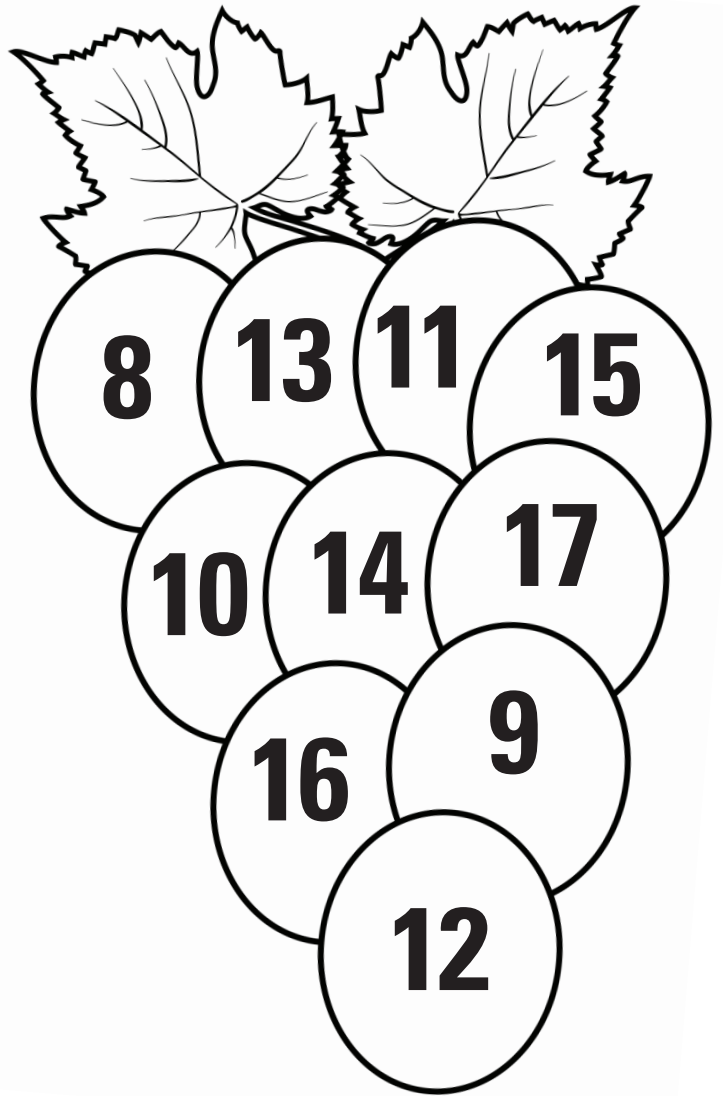

# Mooove It Subtraction

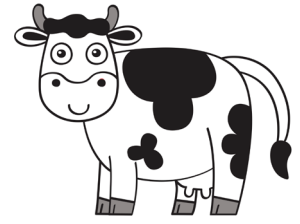

**Building Fluency:** adding and subtracting within 20

**Materials:** gameboard, pair of dice, 8 game markers for each player

**Number of Players:** 2

**Directions:**

1. Players take turns.
2. Roll a pair of dice and add the numbers together.
3. Subtract the sum from 14.
4. Place a colored marker on the difference.
5. If the square already has a player's marker on it, the player may move that marker off the board and replace it with their own marker.
6. The winner is the first player to use all of their colored markers.

**Variation/Extension:** Use the additional game board. Roll the die, add the numbers together and subtract from 20 or a number of their choice. Students can create their own gameboard.

7	10	5	11
6	5	4	6
9	3	9	7
2	7	4	8
10	3	5	7

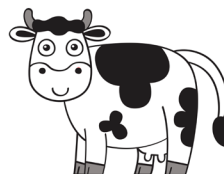

# Moove It Subtraction

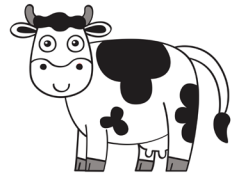
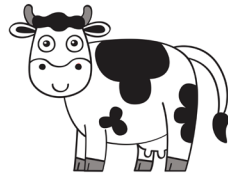
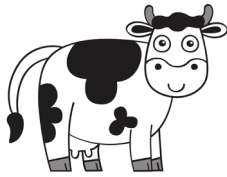
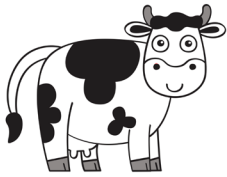

<b>18</b>	<b>14</b>	<b>12</b>	<b>9</b>
<b>16</b>	<b>9</b>	<b>10</b>	<b>11</b>
<b>4</b>	<b>13</b>	<b>8</b>	<b>14</b>
<b>16</b>	<b>10</b>	<b>15</b>	<b>10</b>
<b>14</b>	<b>8</b>	<b>18</b>	<b>13</b>

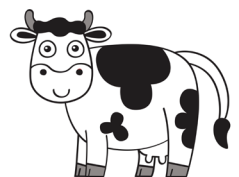
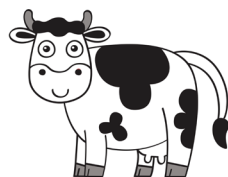
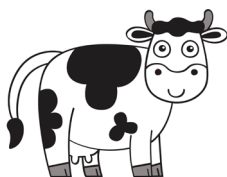
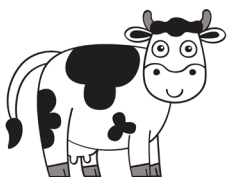

# Road Rally

**Building Fluency:** adding and subtracting within 20 and 100



**Materials:** gameboard, marker for each player, game cards

**Number of Players:** 2-4

**Directions:**

1. Players take turns drawing a card and answering the questions.
2. If the player answers the question correctly, they follow the directions on the card. If the player answers the question incorrectly, they lose a turn.
3. Play continues until one player reaches the finish flag. Shuffle and reuse cards as needed.

**Variation/Extension:** Have students write the problems in their math notebooks or label problem types. Various sets of cards are included for your convenience.

You leave pit area in record time... <b>MOVE AHEAD ONE SPACE</b>					
<b>START</b>				<b>FINISH</b>	
					Caution flag... <b>LOSE A TURN</b>
Caution flag... <b>LOSE A TURN</b>					You overtake car ahead... <b>MOVE AHEAD ONE SPACE</b>
Need a new tire... <b>MOVE BACK ONE SPACE</b>			Car ahead wrecks... <b>MOVE AHEAD ONE SPACE</b>		Low on fuel... <b>LOSE A TURN</b>



## Addition and Subtraction Under 20 Cards

**1**

Zac has six cups of juice for his party.  
He fills eight more cups.  
How many cups does he have now?

**MOVE 1 SPACE****2**

Susie has eleven notebooks for her  
friends in class. Jeff has seven notebooks for  
his class. How many notebooks do  
they have for the class all together?

**MOVE 1 SPACE****3**

Sam has seven pieces of candy in  
a treat bag. He eats two pieces of  
candy. How many pieces of candy  
are in the treat bag now?

**MOVE 2 SPACES****4**

There are nine boys and girls in  
the gym. Five of the kids are boys.  
How many are girls?

**MOVE 1 SPACE****5**

Amanda has eleven pens. She loses  
a few. Now Amanda has seven.  
How many pens did she lose?

**MOVE 3 SPACES****6**

Scott and Cindy have fifteen crayons all  
together. Cindy has some. Scott has five.  
How many crayons does Cindy have?

**MOVE 1 SPACE****7**

Six kids were playing on the swings. Twelve  
kids were playing on the slide. How many  
kids were playing on the playground?

**MOVE 1 SPACE****8****CRASH!!****MOVE BACK 2 SPACES****9**

Mr. Hunt had three magazines on the shelf  
and six books on the shelf? How many  
magazines and books are on the shelf?

**MOVE 2 SPACES****10**

Five ducks were swimming in the pond.  
Seven geese were eating grass around  
the pond. How many ducks and  
geese were at the pond?

**MOVE 1 SPACE****ANSWER KEY – Addition and Subtraction Under 20 Cards**

1. 14 cups 2. 18 notebooks 3. 5 pieces 4. 4 girls 5. 4 pens 6. 10 crayons 7. 18 kids 9. 9 magazines &amp; 4 books 10. 12 ducks &amp; geese

## Addition and Subtraction Under 20 Cards

11

Mrs. Smith has six erasers in her desk. She finds eight more erasers. How many erasers does she have in all?

**MOVE 1 SPACE**

12

There are fourteen kids on a bus for a field trip. Six kids get off of the bus. How many kids are on the bus now?

**MOVE 2 SPACES**

13

Sally and Ted have ten jump ropes. Ted has seven jump ropes. How many jump ropes does Sally have?

**MOVE 1 SPACE**

14

Mrs. Smith has six erasers in her desk. She found some more erasers. Now she has nine. How many erasers did she find?

**MOVE 2 SPACES**

15

Jill found five pieces of trash in the cafeteria. Bob found some pieces of trash. They have twelve pieces of trash together. How many did Bob find?

**MOVE 1 SPACE**

16

Greg collected four shells at the beach. His sister, Linda, collected some more. They now have thirteen shells altogether. How many shells did Linda collect?

**MOVE 1 SPACE**

17

Max has eight pencils. Three are red and the rest are blue. How many pencils are blue?

**MOVE 1 SPACE**

18

Fifteen bags of chips are on the table. Eight are corn chips and the others are potato chips. How many are potato chips?

**MOVE 1 SPACE**

19

There are twenty flowers in a vase. Nine are red and the rest are yellow. How many flowers are yellow?

**MOVE 2 SPACES**

20

Lily has eight apples. Jessica has four apples. How many fewer apples does Jessica have than Lily?

**MOVE 1 SPACE****ANSWER KEY – Addition and Subtraction Under 20 Cards**

11. 14 erasers 12. 8 kids 13. 3 jump ropes 14. 3 erasers 15. 7 pieces 16. 9 shells 17. 5 pencils 18. 7 bags 19. 11 flowers 20. 4 fewer

## Addition and Subtraction Under 20 Cards

21

Alex has ten pencils. Rex has four pencils. How many more pencils does Alex have than Rex?

**MOVE 1 SPACE**

22

Mary has fifteen marbles. Riley has nine marbles. How many fewer marbles does Riley have than Mary?

**MOVE 1 SPACE**

23

Karen has three pieces of gum. Sally has twelve pieces of gum. How many more pieces of gum does Sally have than Karen?

**MOVE 2 SPACES**

24

Frank has five stickers. Lisa has fifteen stickers. How many fewer stickers does Frank have than Lisa?

**MOVE 1 SPACE**

25

**CRASH!!**

**LOSE YOUR TURN**

26

A farm has five pigs and eight cows. How many more cows than pigs are on the farm?

**MOVE 1 SPACE**

27

Julie has three more apples than Lucy. Lucy has two apples. How many apples does Julie have?

**MOVE 1 SPACE**

28

Bob has eight more marbles than Stan. Stan has five marbles. How many marbles does Bob have?

**MOVE 1 SPACE**

29

Sara has ten more cookies than Trish. Trish has seven cookies. How many cookies does Sara have?

**MOVE 1 SPACE**

30

**CRASH!!**

**GO BACK 1 SPACE**

**ANSWER KEY – Addition and Subtraction Under 20 Cards**

21. 6 more    22. 6 fewer    23. 9 more    24. 10 fewer    26. 3 more    27. 5 apples    28. 13 marbles    29. 17 cookies

## Addition and Subtraction Under 20 Cards

31

**CRASH!!****LOSE YOUR TURN**

32

Lucy has six fewer apples than Julie.  
Julie has twelve apples.  
How many apples does Lucy have?

**MOVE 1 SPACE**

33

Mrs. Saddle has nine fewer horses  
than Sal. Sal has fourteen horses.  
How many horses does Mrs. Saddle have?

**MOVE 1 SPACE**

34

Greg has eight fewer bags of candy than  
Henry. Henry has fourteen bags of candy.  
How many bags of candy does Greg have?

**MOVE 2 SPACES**

35

Mr. Scott has seventeen students in his class.  
Six of them are girls. How many are boys?

**MOVE 1 SPACE**

36

Ron's farm grew some watermelons.  
Sal's farm grew four watermelons. Both farmers  
grew nineteen watermelons all together.  
How many watermelons did Ron grow?

**MOVE 1 SPACE**

37

There were five red cars and six  
blue cars in the parking lot.  
How many cars were there in all?

**MOVE 1 SPACE**

38

**CRASH!!****MOVE BACK 1 SPACE**

39

**CRASH!!****MOVE BACK 2 SPACES**

40

**CRASH!!****MOVE BACK 2 SPACES****ANSWER KEY – Addition and Subtraction Under 20 Cards**

32. 6 apples 33. 5 horses 34. 6 bags 35. 11 boys 36. 15 watermelons 37. 11 cars

## Addition and Subtraction Up to 100 Cards

**1**

Zac has fifteen cups of juice for his party. He fills eleven more cups. How many cups does he have now?

**MOVE 1 SPACE****2**

Susie has twenty notebooks for her friends in class. Jeff has eighteen notebooks for his class. How many notebooks do they have for the class all together?

**MOVE 1 SPACE****3**

Sam has forty-four pieces of candy in a treat bag. He eats nineteen pieces of candy. How many pieces of candy are in the treat bag now?

**MOVE 2 SPACES****4**

There are twenty-one boys and girls in the gym. Sixteen of the kids are boys. How many are girls?

**MOVE 1 SPACE****5**

Amanda has fifty-two pens. She loses a few. Now Amanda has forty. How many pens did she lose?

**MOVE 3 SPACES****6**

Scott and Cindy have eighty-five crayons all together. Cindy has some. Scott has fifty-two. How many crayons does Cindy have?

**MOVE 1 SPACE****7**

Seventeen kids were playing on the swings. Twelve kids were playing on the slide. How many kids were playing on the playground?

**MOVE 1 SPACE****8****CRASH!!****MOVE BACK 2 SPACES****9**

Mr. Hunt had thirty magazines on the shelf and sixteen books on the shelf? How many magazines and books are on the shelf?

**MOVE 2 SPACES****10**

Thirteen ducks were swimming in the pond. Seventeen geese were eating grass around the pond. How many ducks and geese were at the pond?

**MOVE 1 SPACE****ANSWER KEY – Addition and Subtraction Up to 100 Cards**

1. 26 cups 2. 38 notebooks 3. 25 pieces 4. 5 girls 5. 12 pens 6. 33 crayons 7. 29 kids 9. 46 magazines &amp; books 10. 30 ducks &amp; geese

## Addition and Subtraction Up to 100 Cards

**11**

**Mrs. Smith has forty-two erasers in her desk. She finds twenty-eight more erasers. How many erasers does she have in all?**

**MOVE 1 SPACE****12**

**There were forty-two kids on a bus for a field trip. Twenty-two kids get off of the bus. How many kids are on the bus now?**

**MOVE 2 SPACES****13**

**Sally and Ted have 100 jump ropes. Ted has sixty-three jump ropes. How many jump ropes does Sally have?**

**MOVE 1 SPACE****14**

**Mrs. Smith has sixty-four erasers in her desk. She found some more erasers. Now she has ninety-eight. How many erasers did she find?**

**MOVE 2 SPACES****15**

**Jill found fifteen pieces of trash in the cafeteria. Bob found some pieces of trash. They have twenty-six pieces of trash together. How many did Bob find?**

**MOVE 1 SPACE****16**

**Greg collected forty-eight shells at the beach. His sister, Linda, collected some more. They now have fifty-one shells altogether. How many shells did Linda collect?**

**MOVE 1 SPACE****17**

**Max has seventy-eight pencils. Thirty-seven are red and the rest are blue. How many pencils are blue?**

**MOVE 1 SPACE****18**

**Fifty-one bags of chips are on the table. Twenty-one are corn chips and the others are potato chips. How many are potato chips?**

**MOVE 1 SPACE****19**

**There are seventy-three flowers in vases. Forty-six are red and the rest are yellow. How many flowers are yellow?**

**MOVE 2 SPACES****20**

**Lily has twenty-eight apples. Jessica has twenty-four apples. How many fewer apples does Jessica have than Lily?**

**MOVE 1 SPACE****ANSWER KEY – Addition and Subtraction Up to 100 Cards**

11. 70 erasers 12. 20 kids 13. 37 jump ropes 14. 34 erasers 15. 11 pieces 16. 3 shells 17. 41 pencils 18. 30 bags 19. 27 flowers 20. 4 fewer

21

Alex has thirty pencils. Rex has fourteen pencils. How many more pencils does Alex have than Rex?

MOVE 1 SPACE

22

Mary has fifty marbles. Riley has nineteen marbles. How many fewer marbles does Riley have than Mary?

MOVE 1 SPACE

23

Karen has thirty pieces of gum. Sally has twenty pieces of gum. How many more pieces of gum does Sally have than Karen?

MOVE 2 SPACES

24

Frank has fifteen stickers. Lisa has fifty stickers. How many fewer stickers does Frank have than Lisa?

MOVE 1 SPACE

25

# CRASH!!

LOSE YOUR TURN

26

A farm has twelve pigs and eighty cows. How many more cows than pigs are on the farm?

MOVE 1 SPACE

27

Julie has thirty more apples than Lucy. Lucy has twenty-two apples. How many apples does Julie have?

MOVE 1 SPACE

28

Bob has eighty more marbles than Stan. Stan has fifteen marbles. How many marbles does Bob have?

MOVE 1 SPACE

29

Sara has twenty-seven more cookies than Trish. Trish has seventy-one cookies. How many cookies does Sara have?

MOVE 1 SPACE

30

# CRASH!!

GO BACK 1 SPACE

**ANSWER KEY – Addition and Subtraction Up to 100 Cards**

21. 16 more   22. 31 fewer   23. 10 more   24. 35 fewer   26. 68 more   27. 52 apples   28. 95 marbles   29. 98 cookies

31

**CRASH!!****LOSE YOUR TURN**

32

Lucy has sixteen fewer apples than Julie.  
Julie has sixty-six apples. How many  
apples does Lucy have?

**MOVE 1 SPACE**

33

Mrs. Saddle has sixteen fewer horses  
than Sal. Sal has thirty horses. How many  
horses does Mrs. Saddle have?

**MOVE 1 SPACE**

34

Greg has eighteen fewer bags of candy  
than Henry. Henry has forty bags of candy.  
How many bags of candy does Greg have?

**MOVE 2 SPACES**

35

Mr. Scott has twenty-seven students  
in his class. Sixteen of them are girls.  
How many are boys?

**MOVE 1 SPACE**

36

Ron's farm grew some watermelons.  
Sal's farm grew fifty-four watermelons.  
Both farmers grew eighty-three  
watermelons all together. How many  
watermelons did Ron grow?

**MOVE 1 SPACE**

37

There were nineteen red cars and  
thirty-six blue cars in the parking lot.  
How many cars were there in all?

**MOVE 1 SPACE**

38

**CRASH!!****MOVE BACK 1 SPACE**

39

**CRASH!!****MOVE BACK 2 SPACES**

40

**CRASH!!****MOVE BACK 2 SPACES****ANSWER KEY – Addition and Subtraction Up to 100 Cards**

32. 50 apples 33. 14 horses 34. 22 bags 35. 11 boys 36. 29 watermelons 37. 55 cars



Result, Change, Total, Addend, Difference, Smaller, and Bigger Unknown Addition and Subtraction Under 20 (Review)

**1**

Zac had some cups of juice for his party. He filled eight more cups. Now he has 14 cups of juice. How many cups of juice did Zac have to start with?

**MOVE 1 SPACE****2**

Susie had some notebooks for her friends in class. She got seven more notebooks. Now she has eighteen notebooks for her class. How many notebooks did Sallie have to begin with?

**MOVE 1 SPACE****3**

Sam has some candy in a treat bag. He eats two pieces of candy. There are seven pieces of candy are in the treat bag now. How many pieces of candy did Sam start with?

**MOVE 2 SPACES****4**

Some children were in the gym. Five more came in. Now there are nine children in the gym. How many children were in the gym to start with?

**MOVE 1 SPACE****5**

Amanda had some pens. She loses four pens. Now Amanda has seven pens. How many pens did Amanda have to begin with?

**MOVE 3 SPACES****6**

Scott had some crayons. He got five more. Now he has fifteen crayons. How many crayons did Scott have to start?

**MOVE 1 SPACE****7**

Some kids were playing on the playground. Twelve more kids came out to play. Now there are eighteen kids on the playground. How many kids were on the playground at the beginning?

**MOVE 1 SPACE****8**

Bruce had some toys. He loses seven toys. Now Bruce has seven toys. How many toys did Bruce have to begin with?

**MOVE 3 SPACES****9**

Mr. Hunt had some books on the shelf. He put three more books on the shelf. Now there are nine books on the shelf. How many books did Mr. Hunt have on the shelf to begin with?

**MOVE 2 SPACES****10**

Some ducks were swimming in the pond. Seven of the ducks flew away. Now there are five ducks swimming in the pond. How many ducks were at the pond to begin with?

**MOVE 1 SPACE****ANSWER KEY – Result, Change, Total, Addend, Difference, Smaller, and Bigger Unknown Addition and Subtraction Under 20 (Review)**

1. 6 cups   2. 11 notebooks   3. 9 pieces   4. 4 children   5. 11 pens   6. 10 crayons   7. 6 kids   8. 14 toys   9. 6 books   10. 12 ducks

Result, Change, Total, Addend, Difference, Smaller, and Bigger Unknown Addition and Subtraction Under 20 (Review)

11

Mrs. Smith had some erasers in her desk. She finds eight more erasers. Now she has fourteen. How many erasers did Mrs. Smith have to start with?

MOVE 1 SPACE

12

There were some kids on a bus for a field trip. Six kids got off the bus. There are eight kids still on the bus. How many kids were on the bus at the start of the field trip?

MOVE 2 SPACES

13

Sally had some jump ropes. She gave three jump ropes to Ted. Now she has twelve. How many jump ropes did Sally have to begin with?

MOVE 1 SPACE

14

Mrs. Smith had some erasers in her desk. She gave six erasers to her students. Now she has nine erasers. How many erasers did Mrs. Smith have in her desk to start with?

MOVE 2 SPACES

15

Jill picked up seven fewer pieces of trash than Bob. Jill picked up five pieces. How many pieces of trash did Bob pick up?

MOVE 1 SPACE

16

Greg had some shells. He collected four more. Now he has thirteen shells. How many shells did Greg have to begin with?

MOVE 1 SPACE

17

Max had some pencils. He bought five more. Now he has eight pencils. How many pencils did Max have to begin with?

MOVE 1 SPACE

18

Natasha has seven more bags of chips than Jenny. Natasha has fifteen bags of chips. How many bags of chips does Jenny have?

MOVE 1 SPACE

19

Katie has eleven fewer flowers than Emily. Katie has nine flowers. How many flowers does Emily have?

MOVE 2 SPACES

20

Lily has four more apples than Jessica. Lily has 8 apples. How many apples does Jessica have?

MOVE 1 SPACE

**ANSWER KEY – Result, Change, Total, Addend, Difference, Smaller, and Bigger Unknown Addition and Subtraction Under 20 (Review)**

11. 6 erasers 12. 14 kids 13. 15 jump ropes 14. 15 erasers 15. 12 pieces 16. 9 shells 17. 3 pencils 18. 8 bags 19. 20 flowers 20. 4 apples

Result, Change, Total, Addend, Difference, Smaller, and Bigger Unknown Addition and Subtraction Under 20 (Review)

21

Alex has six more pencils than Rex.  
Alex has ten pencils. How many  
pencils does Rex have?

MOVE 1 SPACE

22

Mary has six more marbles than Riley.  
Mary has fifteen marbles. How many  
marbles does Riley have?

MOVE 1 SPACE

23

Sally has nine more pieces of gum than  
Karen. Sally has twelve pieces of gum.  
How many pieces of gum does Karen have?

MOVE 2 SPACES

24

Frank has ten fewer stickers than Lisa.  
Frank has five stickers. How many  
stickers does Lisa have?

MOVE 1 SPACE

25

# CRASH!!

LOSE YOUR TURN

26

Farmer Kitty has five more pigs than  
Farmer Tania. Farmer Kitty has eight pigs.  
How pigs does Farmer Tania have?

MOVE 1 SPACE

27

Julie has three more apples than Lucy.  
Julie has five apples. How many  
apples does Lucy have?

MOVE 1 SPACE

28

Bob has eight more marbles than Stan.  
Bob has thirteen marbles. How many  
marbles does Stan have?

MOVE 1 SPACE

29

Sara has ten more cookies than Trish.  
Sara has seventeen cookies.  
How many cookies does Trish have?

MOVE 1 SPACE

30

# CRASH!!

GO BACK 1 SPACE

ANSWER KEY – Result, Change, Total, Addend, Difference, Smaller, and Bigger Unknown Addition and Subtraction Under 20 (Review)

21. 4 pencils 22. 9 marbles 23. 3 pieces 24. 15 stickers 26. 3 pigs 27. 2 apples 28. 5 marbles 29. 7 cookies

31

**CRASH!!****LOSE YOUR TURN**

32

Lucy has six fewer apples than Julie.  
Lucy has six apples. How many  
apples does Julie have?

**MOVE 1 SPACE**

33

Mrs. Saddle has nine fewer horses than Sal.  
Mrs. Saddle has six horses.  
How many horses does Sal have?

**MOVE 1 SPACE**

34

Greg has eight fewer bags of candy  
than Henry. Greg has six bags of candy.  
How many bags of candy does Henry have?

**MOVE 2 SPACES**

35

Mr. Scott has nine fewer students than  
Mrs. Smith. Mr. Scott has six students.  
How many students does Mrs. Smith have?

**MOVE 1 SPACE**

36

Ron grew 15 fewer watermelons than Sal.  
Ron grew 4 watermelons. How many  
watermelons did Sal grow?

**MOVE 1 SPACE**

37

There are five fewer red cars in the  
parking lot than blue cars. There are  
six red cars in the parking lot. How many  
blue cars are in the parking lot?

**MOVE 1 SPACE**

38

**CRASH!!****MOVE BACK 1 SPACE**

39

**CRASH!!****MOVE BACK 2 SPACES**

40

**CRASH!!****MOVE BACK 2 SPACES**

**ANSWER KEY – Addition and Subtraction Under 20 Cards**

1. 14 cups
2. 18 notebooks
3. 5 pieces
4. 4 girls
5. 4 pens
6. 10 crayons
7. 18 kids
9. 9 magazines & 4 books
10. 12 ducks & geese
11. 14 erasers
12. 8 kids
13. 3 jump ropes
14. 3 erasers
15. 7 pieces
16. 9 shells
17. 5 pencils
18. 7 bags
19. 11 flowers
20. 4 fewer
21. 6 more
22. 6 fewer
23. 9 more
24. 10 fewer
26. 3 more
27. 5 apples
28. 13 marbles
29. 17 cookies
32. 6 apples
33. 5 horses
34. 6 bags
35. 11 boys
36. 15 watermelons
37. 11 cars

**ANSWER KEY – Addition and Subtraction Up to 100 Cards**

1. 26 cups
2. 38 notebooks
3. 25 pieces
4. 5 girls
5. 12 pens
6. 33 crayons
7. 29 kids
9. 46 magazines & books
10. 30 ducks & geese
11. 70 erasers
12. 20 kids
13. 37 jump ropes
14. 34 erasers
15. 11 pieces
16. 3 shells
17. 41 pencils
18. 30 bags
19. 27 flowers
20. 4 fewer
21. 16 more
22. 31 fewer
23. 10 more
24. 35 fewer
26. 68 more
27. 52 apples
28. 95 marbles
29. 98 cookies
32. 50 apples
33. 14 horses
34. 22 bags
35. 11 boys
36. 29 watermelons
37. 55 cars

**ANSWER KEY – Result, Change, Total, Addend, Difference, Smaller, and Bigger Unknown Addition and Subtraction Under 20 (Review)**

1. 6 cups
2. 11 notebooks
3. 9 pieces
4. 4 children
5. 11 pens
6. 10 crayons
7. 6 kids
8. 14 toys
9. 6 books
10. 12 ducks
11. 6 erasers
12. 14 kids
13. 15 jump ropes
14. 15 erasers
15. 12 pieces
16. 9 shells
17. 3 pencils
18. 8 bags
19. 20 flowers
20. 4 apples
21. 4 pencils
22. 9 marbles
23. 3 pieces
24. 15 stickers
26. 3 pigs
27. 2 apples
28. 5 marbles
29. 7 cookies
32. 12 apples
33. 15 horses
34. 14 bags
35. 15 students
36. 11 watermelon
37. 11 blue cars

# Space Chase

**Building Fluency:** adding and subtracting within 20

**Materials:** gameboard, pair of dice, colored marker for each player

**Number of Players:** 2-4

**Directions:**

1. Players take turns.
2. Roll the dice and add the numbers.
3. Subtract the sum from 15.
4. If the difference is on the next planet, the player may move ahead. If the difference is not on the next planet, the player loses their turn.
5. Play continues until a player reaches the moon.

**Variation/Extension:** Subtract the sum from a different number (eg. 20, 18, etc.). Students could create their own game board.

**START** →

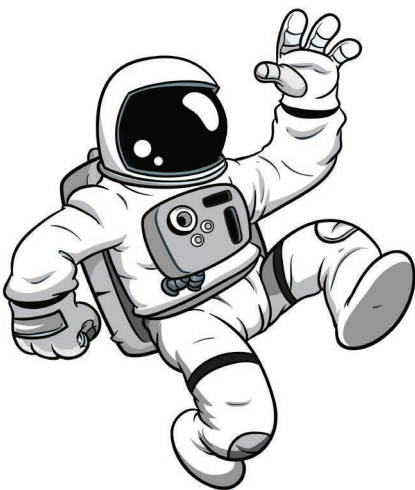
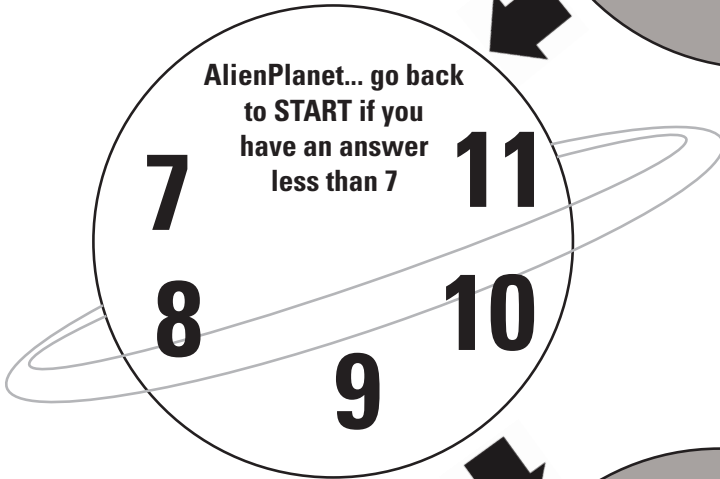
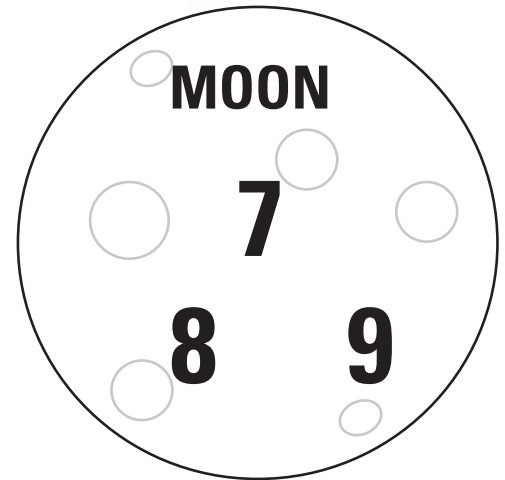
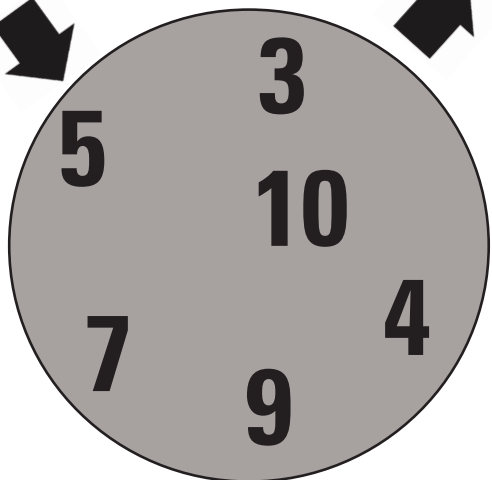
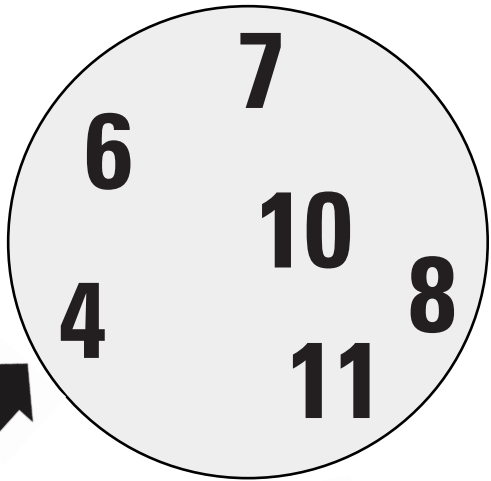
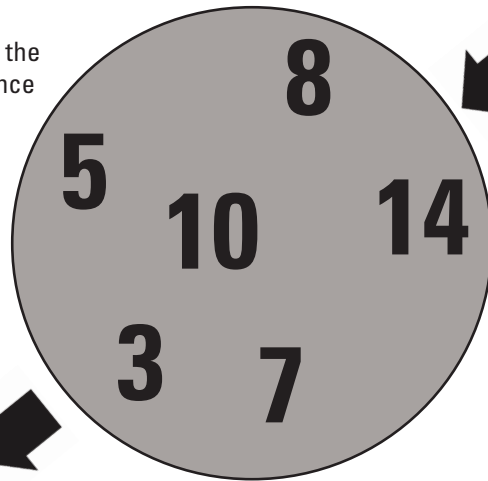
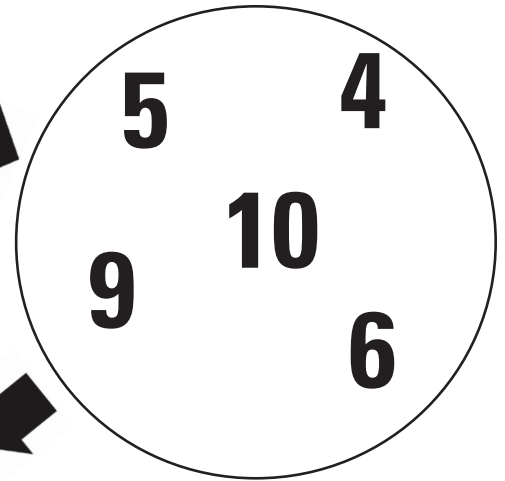



# Numberville

**Building Fluency:** adding within 20; determine if a number is odd or even

**Materials:** gameboard, marker for each player, 4 sets of number cards 0-10

**Number of Players:** 2

**Directions:**

1. One player follows Odd Street and the other player follows Even Street.
2. Take turns drawing two cards. Add the two numbers on the cards together.
3. If the sum is odd, the player following Odd Street moves one space. If the sum is even, the player following Even Street moves one space.
4. Play continues until one player reaches home.

**Variation/Extension:** Players could draw cards and subtract the sum from 20. Players could draw one card and determine if the number is odd or even.

The gameboard consists of two vertical columns of 10 squares each, labeled "HOME" at the top. In the center, there are two houses at the top, a row of three buildings in the middle, and a "START" area at the bottom. Two street signs, "Odd Street" and "Even Street", are positioned above the "START" area.



**0****1****2****3****4****5****6****7****8****9****10****0****1****2****3**

**4****5****6****7****8****9****10****0****1****2****3****4****5****6****7**

**8****9****10****0****1****2****3****4****5****6****7****8****9****10**

# Odds and Evens

**Building Fluency:** adding within 20; determine if a number is odd or even

**Materials:** gameboard, 8 markers per player, spinner (paperclip and pencil)

**Number of Players:** 2

**Directions:**

1. Each player spins one of the spinners. The two results are added. Determine if the sum is odd or even.
2. If the sum is even, the player that is "Even Steven" places a marker on their section of the gameboard. If the sum is odd, the player that is "Odd Rod" places a marker on their section of the gameboard.
3. Play continues until one player fills all of his boxes on the gameboard.

**Variation/Extension:** Add the numbers on the spinners together, and subtract from 20. Determine if the number is odd or even.



**ODD ROD**

--	--	--	--	--	--	--	--

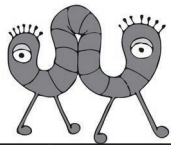

**EVEN STEVEN**

--	--	--	--	--	--	--	--

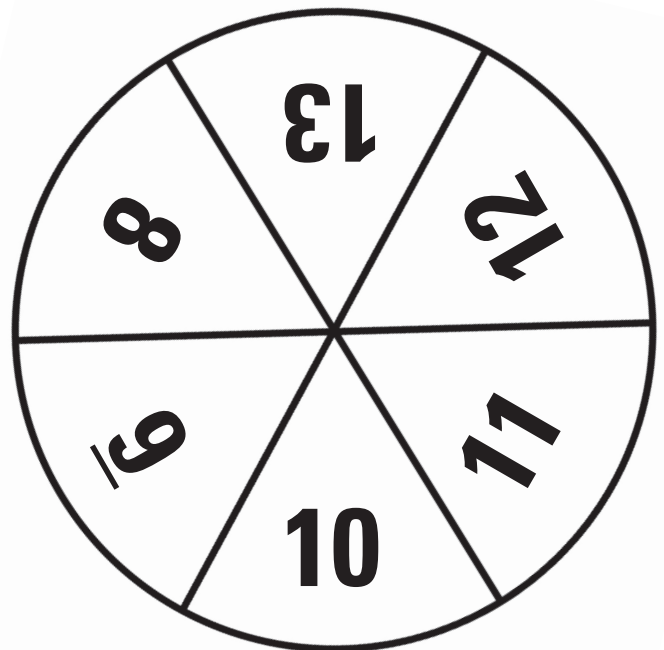
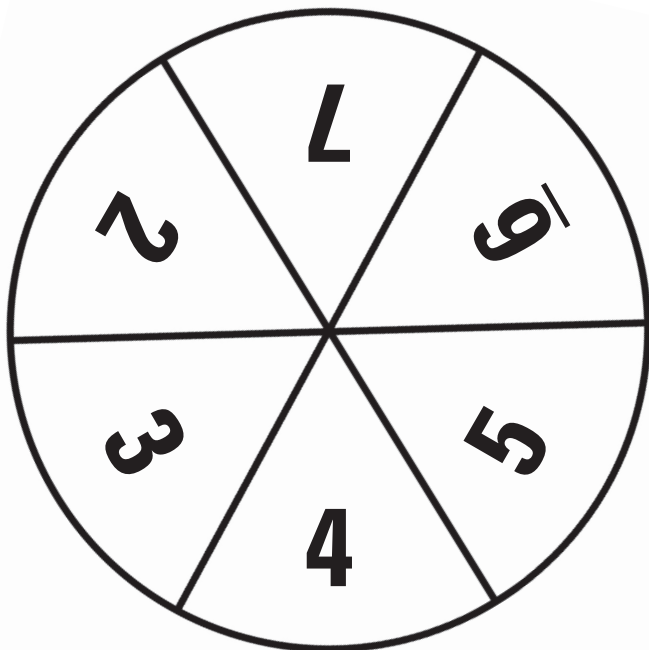

# Spin An Array

**Building Fluency:** Building arrays

**Materials:** gameboard, 2 spinners (pencils and paperclips), 4 different colored markers for each player, paper, set of 25 counters

**Number of Players:** 2-4

**Directions:**

1. In turn, players spin the two spinners to decide how many rows and columns will be in the array.
2. Player builds the array with counters and records the addition equation on paper.
3. If the sum is on the gameboard, the player puts one of his colored markers on the fish. If that sum is already covered, the player loses that turn.
4. Play continues until a player has put all four of his counters on the board.

**Variation/Extension:** Play with number cards 1-5 instead of spinners. Or players can partition rectangles (2.G.2) instead of building arrays.

**Columns**

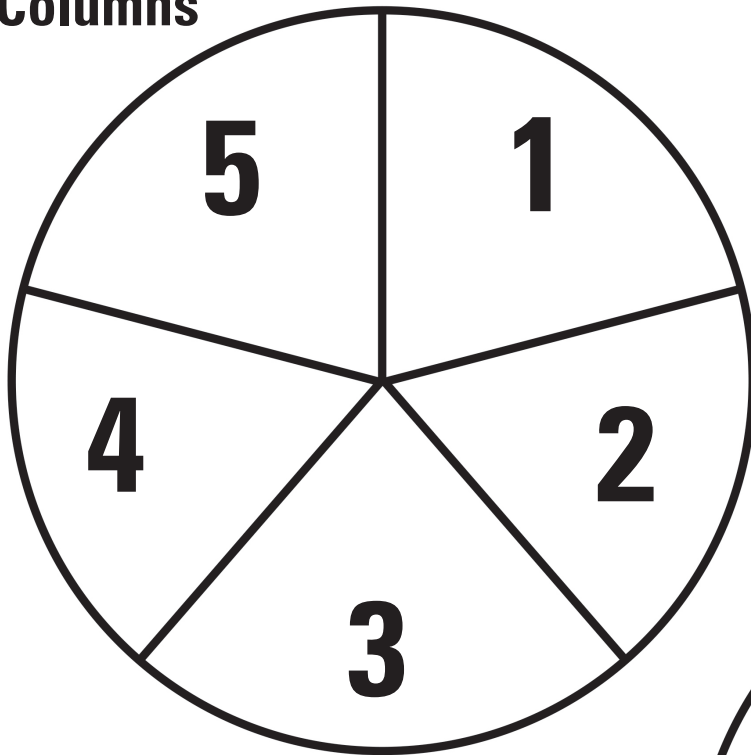

**Rows**

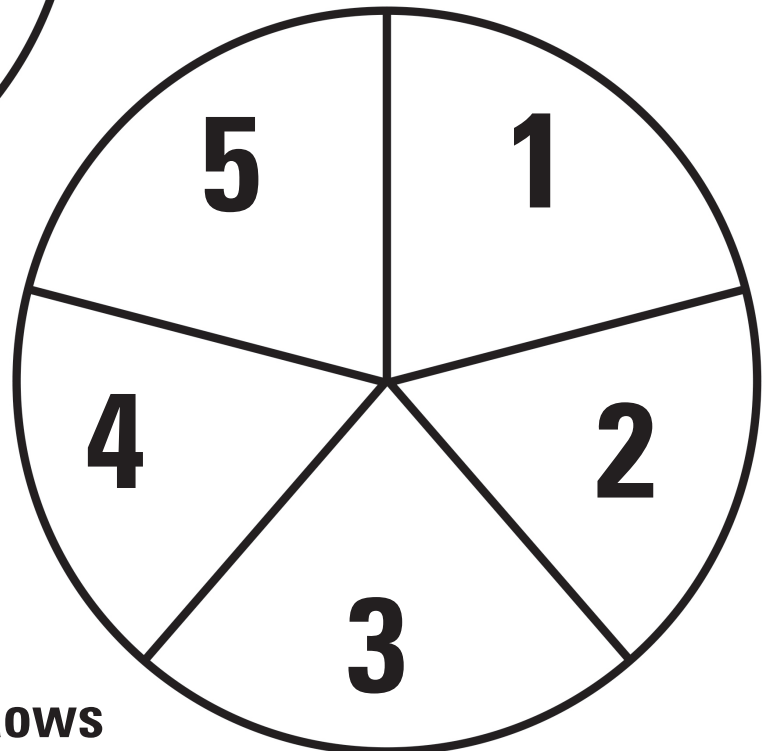

## Spin An Array

<b>9</b>	<b>10</b>	<b>5</b>	<b>2</b>	<b>15</b>
<b>4</b>	<b>25</b>	<b>12</b>	<b>3</b>	<b>8</b>
<b>10</b>	<b>3</b>	<b>6</b>	<b>25</b>	<b>15</b>
<b>8</b>	<b>4</b>	<b>20</b>	<b>12</b>	<b>16</b>
<b>20</b>	<b>5</b>	<b>6</b>	<b>9</b>	<b>2</b>
<b>5</b>	<b>16</b>	<b>2</b>	<b>15</b>	<b>9</b>

# Closest to 1000

**Building Fluency:** place value understanding

**Materials:** spinner (pencil and paper clip), base ten blocks, recording sheet

**Number of Players:** 2-6

**Directions:**

1. Spin the spinner.
2. All players choose to take that number of ones, tens, or hundreds from the pile of base ten blocks.
3. Then, each player records their number on their recording sheet. (eg. The spin lands on 7. A player can take 7 ones and record 7 on his chart for Spin 1, or he can take 7 tens and record 70, or he can take 7 hundreds and record 700.)
4. After 6 spins, players add the numbers on their charts. The player with the sum closest to 1000, but not more than 1000 is in the winner.

**Variation/Extension:** Students can play closest to 100, and take out the hundreds place OR instead of a spinner, students can use number cards 1-9.

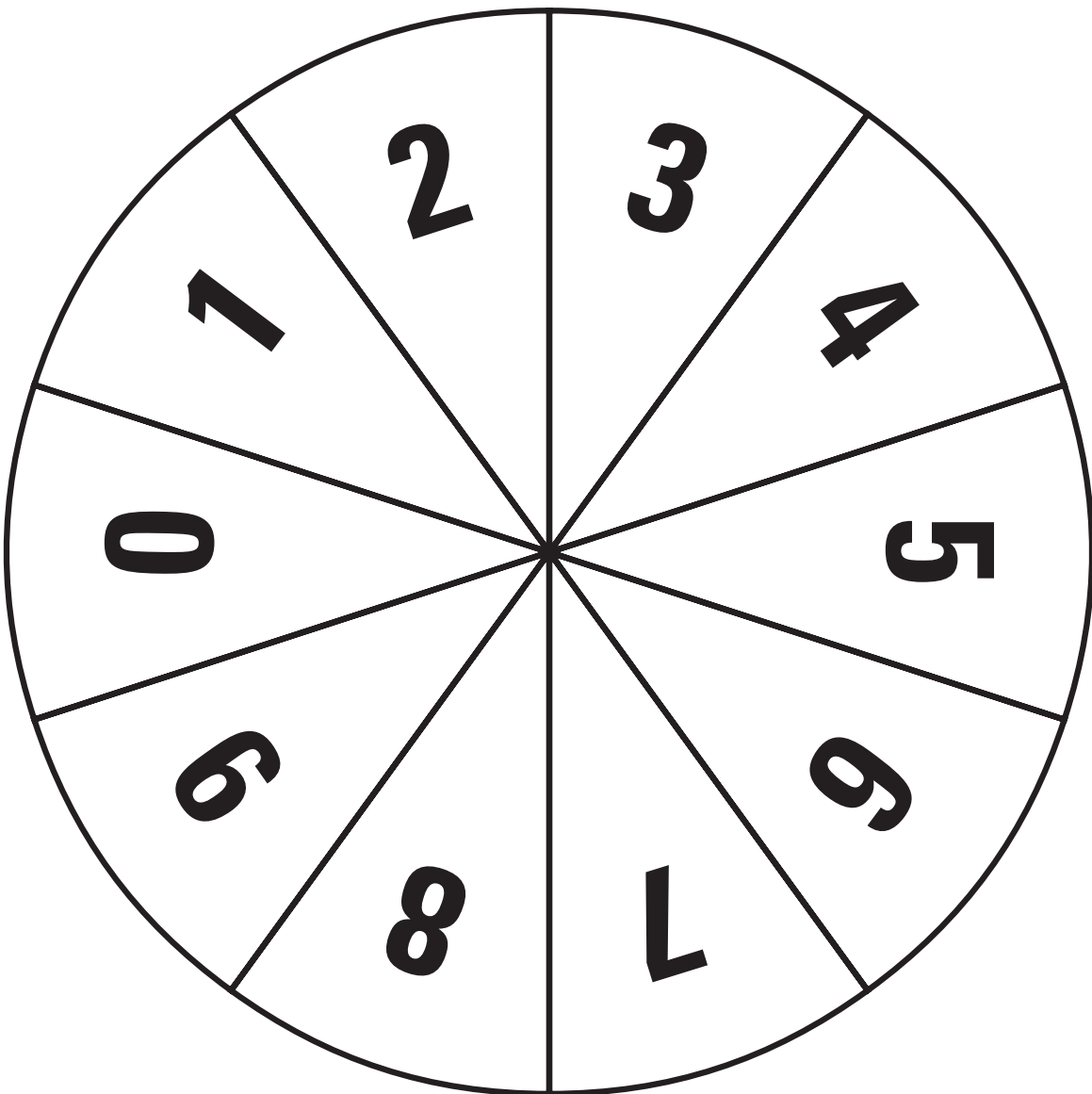
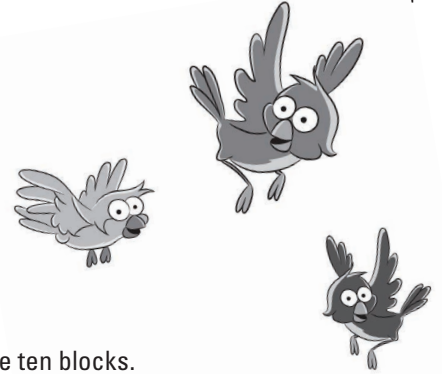

**PLAYER \_\_\_\_\_**

SPINS	HUNDREDS	TENS	ONES
1			
2			
3			
4			
5			
6			
<b>TOTAL</b>			

**PLAYER \_\_\_\_\_**

SPINS	HUNDREDS	TENS	ONES
1			
2			
3			
4			
5			
6			
<b>TOTAL</b>			

**PLAYER \_\_\_\_\_**

SPINS	HUNDREDS	TENS	ONES
1			
2			
3			
4			
5			
6			
<b>TOTAL</b>			

**PLAYER \_\_\_\_\_**

SPINS	HUNDREDS	TENS	ONES
1			
2			
3			
4			
5			
6			
<b>TOTAL</b>			

**PLAYER \_\_\_\_\_**

SPINS	HUNDREDS	TENS	ONES
1			
2			
3			
4			
5			
6			
<b>TOTAL</b>			

**PLAYER \_\_\_\_\_**

SPINS	HUNDREDS	TENS	ONES
1			
2			
3			
4			
5			
6			
<b>TOTAL</b>			



# Hopping to 1000

**Building Fluency:** skip counting by 5s, 10s, and 100s

**Materials:** spinner (pencil and paper clip), a 1000 board, number cards 10-100, marker for each player, paper

**Number of Players:** 2-4

**Directions:**

1. Each player draws a card from the pile to determine where they will start on the chart.
2. Each player places their marker on the chart based on the card they drew.
3. Player 1 spins the spinner to determine how to count when moving their marker.
4. Player 1 will skip count on the board for the next five numbers in sequence based on his spin. For example, if Player 1 draws a 20 as the starting point, they place their marker on the 20. When Player 1 spins, they land on 10s. Player 1 will skip count by 10s beginning at 20 (30, 40, 50, 60, 70) and place their marker on the 70. On the next spin, Player 1 may spin a 2, so they will begin at 70 and skip count by 2 (72, 74, 76, 78, 80), etc.
5. Players will take turns spinning the spinner and moving their marker accordingly.
6. The winner is the player that lands on or over 1000.

**Variation/Extension:** An open number line can be used so students create the number line to be used.  
OR Cards can be varied so that students are only working with specific numbers.

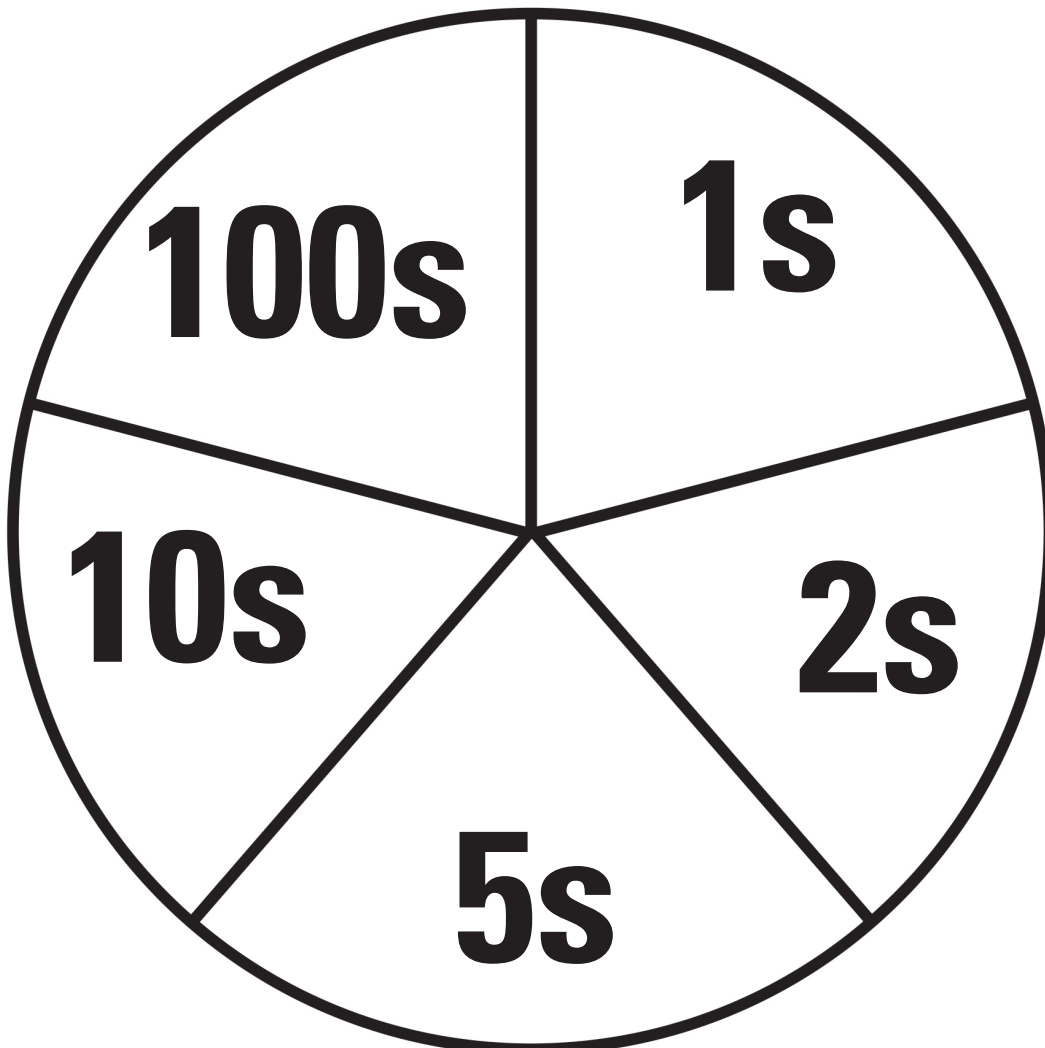
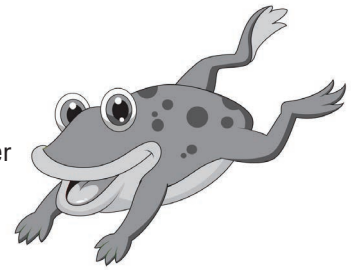

1	2	3	4	5	6	7	8	9	10	11	12	13	14	15	16	17	18	19	20
21	22	23	24	25	26	27	28	29	30	31	32	33	34	35	36	37	38	39	40
41	42	43	44	45	46	47	48	49	50	51	52	53	54	55	56	57	58	59	60
61	62	63	64	65	66	67	68	69	70	71	72	73	74	75	76	77	78	79	80
81	82	83	84	85	86	87	88	89	90	91	92	93	94	95	96	97	98	99	100
101	102	103	104	105	106	107	108	109	110	111	112	113	114	115	116	117	118	119	120
121	122	123	124	125	126	127	128	129	130	131	132	133	134	135	136	137	138	139	140
141	142	143	144	145	146	147	148	149	150	151	152	153	154	155	156	157	158	159	160
161	162	163	164	165	166	167	168	169	170	171	172	173	174	175	176	177	178	179	180
181	182	183	184	185	186	187	188	189	190	191	192	193	194	195	196	197	198	199	200
201	202	203	204	205	206	207	208	209	210	211	212	213	214	215	216	217	218	219	220
221	222	223	224	225	226	227	228	229	230	231	232	233	234	235	236	237	238	239	240
241	242	243	244	245	246	247	248	249	250	251	252	253	254	255	256	257	258	259	260
261	262	263	264	265	266	267	268	269	270	271	272	273	274	275	276	277	278	279	280
281	282	283	284	285	286	287	288	289	290	291	292	293	294	295	296	297	298	299	300
301	302	303	304	305	306	307	308	309	310	311	312	313	314	315	316	317	318	319	320
321	322	323	324	325	326	327	328	329	330	331	332	333	334	335	336	337	338	339	340
341	342	343	344	345	346	347	348	349	350	351	352	353	354	355	356	357	358	359	360
361	362	363	364	365	366	367	368	369	370	371	372	373	374	375	376	377	378	379	380
381	382	383	384	385	386	387	388	389	390	391	392	393	394	395	396	397	398	399	400
401	402	403	404	405	406	407	408	409	410	411	412	413	414	415	416	417	418	419	420
421	422	423	424	425	426	427	428	429	430	431	432	433	434	435	436	437	438	439	440
441	442	443	444	445	446	447	448	449	450	451	452	453	454	455	456	457	458	458	460
461	462	463	464	465	466	467	468	469	470	471	472	473	474	475	476	477	478	479	480
481	482	483	484	485	486	487	488	489	490	491	492	493	494	495	496	497	498	499	500

501	502	350	504	505	506	507	508	509	510	511	512	513	514	515	516	517	518	519	520
521	522	523	524	525	526	527	528	529	530	531	532	533	534	535	536	537	538	539	540
541	542	543	544	545	546	547	548	549	550	551	552	553	554	555	556	557	558	559	560
561	562	563	564	565	566	567	568	569	570	571	572	573	574	575	576	577	578	579	580
581	582	583	584	585	586	587	588	589	590	591	592	593	594	595	596	597	598	599	600
601	602	603	604	605	606	607	608	609	610	611	612	613	614	615	616	617	618	619	620
621	622	623	624	625	626	627	628	629	630	631	632	633	634	635	636	637	638	639	640
641	642	643	644	645	646	647	648	649	650	651	652	653	654	655	656	657	158	659	660
661	662	663	664	665	666	667	668	669	670	671	672	673	674	675	676	677	678	679	680
681	682	683	684	685	686	687	688	689	690	691	692	693	694	695	696	697	698	699	700
701	702	703	704	705	706	707	708	709	710	711	712	713	714	715	716	717	718	719	720
721	722	723	724	725	726	727	728	729	730	731	732	733	734	735	736	737	738	739	740
741	742	743	744	745	746	747	748	749	750	751	752	753	754	755	756	757	758	759	760
761	762	763	764	765	766	767	768	769	770	771	772	773	774	775	776	777	778	779	780
781	782	783	784	785	786	787	788	789	790	791	792	793	794	795	796	797	798	799	800
801	802	803	804	805	806	807	808	809	810	811	812	813	814	815	816	817	818	819	820
821	822	823	824	825	826	827	828	829	830	831	832	833	834	835	836	837	838	839	840
841	842	843	844	845	846	847	848	849	850	851	852	853	854	855	856	857	858	859	860
861	862	863	864	865	866	867	868	869	870	871	872	873	874	875	876	877	878	879	880
881	882	883	884	885	886	887	888	889	890	891	892	893	894	895	896	897	898	899	900
901	902	903	904	905	906	907	908	909	910	911	912	913	914	915	916	917	918	919	920
921	922	923	924	925	926	927	928	929	930	931	932	933	934	935	936	937	938	939	940
941	942	943	944	945	946	947	948	949	950	951	952	953	954	955	956	957	958	958	960
961	962	963	964	965	966	967	968	969	970	971	972	973	974	975	976	977	978	979	980
981	982	983	984	985	986	987	988	989	990	991	992	993	994	995	996	997	998	999	1000

**10****11****12****13****14****15****16****17****18****19****20****21****22****23****24****25****26****27****28****29**

**30****31****32****33****34****35****36****37****38****39****40****41****42****43****44****45****46****47****48****49**

**50****51****52****53****54****55****56****57****58****59****60****61****62****63****64****65****66****67****68****69**

**70****71****72****73****74****75****76****77****78****79****80****81****82****83****84****85****86****87****88****89**

**90**

**91**

**92**

**93**

**94**

**95**

**96**

**97**

**98**

**99**

**100**



# Out Number Your Neighbor

**Building Fluency:** place value understanding; comparing numbers

**Materials:** gameboard, sets of number cards 0-9 (one set per player), counters

**Number of Players:** 2-4

**Directions:**

1. Each player places their set of number cards face down in a pile.
2. Then each player draws one card from their set and places it on the gameboard in any position. Draw cards three times.
3. The player with the largest number wins the round. The winner of the round collects one counter.
4. Play continues until one player has 10 counters.

**Variation/Extension:** Student with the smallest three digit number wins the round.

PLAYER 1

--	--	--

PLAYER 2

--	--	--

PLAYER 3

--	--	--

PLAYER 4

--	--	--

**0****1****2****3****4****5****6****7****8****9****0****1****2****3****4**

**5****6****7****8****9****0****1****2****3****4****5****6****7****8****9**

# Number Concentration

**Building Fluency:** base ten numerals, number names, and expanded form

**Materials:** deck of memory cards

**Number of Players:** 2-4

**Directions:**

1. Place cards face down on the floor in an array.
2. Player 1 turns over two cards. If the cards are matches, the player removes them from the array and takes another turn. If the cards do not match, the player turns the cards over and the next player takes his turn.
3. The game continues until all matches have been made.
4. The winner is the player with the most matches at the end of the game.

**Variation/Extension:** Choose which cards to use during the game instead of using all cards.

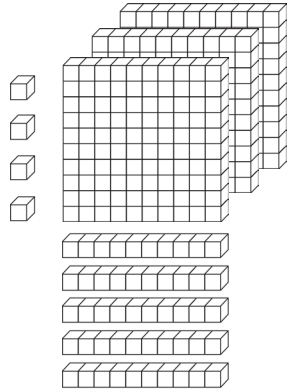
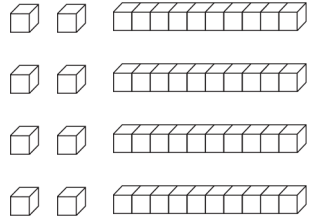
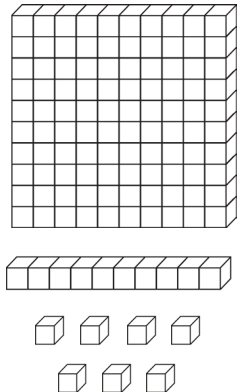
$300+50+4$	<b>354</b>	<b>Three hundred fifty-four</b>	
$40+8$	<b>48</b>	<b>Forty-eight</b>	
$100+10+7$	<b>117</b>	<b>One hundred seventeen</b>	

$200+20+8$

**228**

**Two hundred  
twenty-eight**

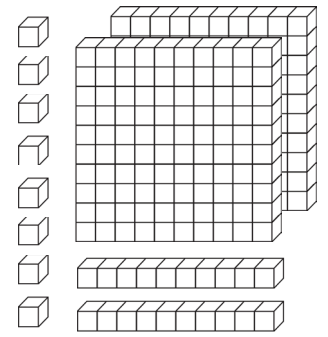

$80+3$

**83**

**Eighty-three**

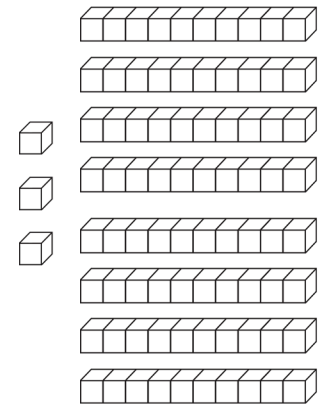

$400+20+2$

**422**

**Four hundred  
twenty-two**

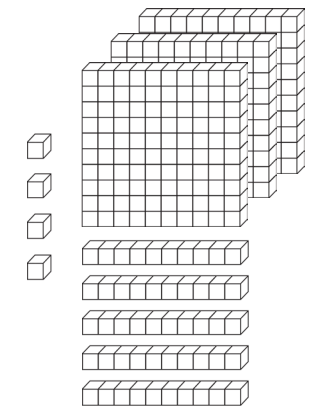

$100+20+1$

**121**

**One hundred  
twenty-one**

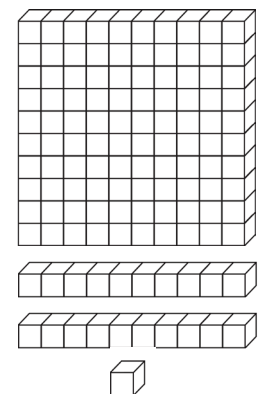

$300+30+7$

**337**

**Three  
hundred  
thirty-seven**

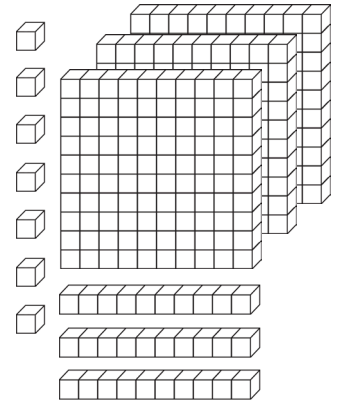

$200+70+3$

**273**

**Two hundred  
seventy-  
three**

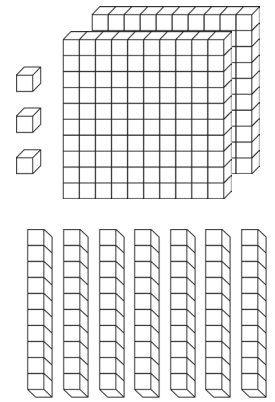

$10+5$

**15**

**Fifteen**

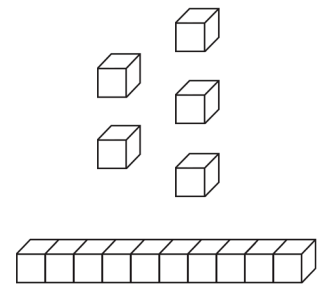

# Greater Gators



**Building Fluency:** adding two digit numbers, comparing numbers

**Materials:** gameboard, pair of dice, recording sheet, 5 markers for each player

**Number of Players:** 2

**Directions:**

1. Player 1 rolls the dice. Player 1 uses the numbers rolled to create a two digit number and writes the number on the recording sheet.
2. Player 2 rolls the dice. Player 2 uses the numbers rolled to create a two digit number and writes the number on the recording sheet.
3. Continue in this way until each player has four two digit numbers.
4. Each player adds his four two digit numbers together.
5. The player with the greater sum wins the round and places one of his markers on the ten frame.
6. Repeat the steps for each round.
7. The winner is the first player to have five markers on the ten frame.

**Variation/Extension:** Students can compare numbers and determine the smaller of the two sums OR for students who have mastered two digit addition with four numbers can begin working with three digit numbers.

## TEN FRAME

**PLAYER 1**    **ROUND** \_\_\_\_\_

<b>1.</b>	
<b>2.</b>	
<b>3.</b>	
<b>4.</b>	
<b>SUM:</b>	

**PLAYER 2**    **ROUND** \_\_\_\_\_

<b>1.</b>	
<b>2.</b>	
<b>3.</b>	
<b>4.</b>	
<b>SUM:</b>	

**PLAYER 1** ROUND \_\_\_\_\_

1.
2.
3.
4.
<b>SUM:</b>

**PLAYER 2** ROUND \_\_\_\_\_

1.
2.
3.
4.
<b>SUM:</b>

**PLAYER 1** ROUND \_\_\_\_\_

1.
2.
3.
4.
<b>SUM:</b>

**PLAYER 2** ROUND \_\_\_\_\_

1.
2.
3.
4.
<b>SUM:</b>

**PLAYER 1** ROUND \_\_\_\_\_

1.
2.
3.
4.
<b>SUM:</b>

**PLAYER 2** ROUND \_\_\_\_\_

1.
2.
3.
4.
<b>SUM:</b>



# Target 1000

**Building Fluency:** adding 10 or 100

**Materials:** gameboard, spinner (pencil and paperclip), 3 sets of number cards 0-9, recording sheet

**Number of Players:** 2

**Directions:**

1. Place one set of number cards on each stack (Hundreds, Tens, Ones).
2. Player 1 draws a number card from each stack to build a number.
3. Player 1 spins the spinner to determine if he should add 10 or 100.
4. Player 1 records his new number on the recording sheet.
5. Player 2 follows steps 2-4.
6. Player 1 spins the spinner to determine if he should add 10 or 100 and then adds to the number he ended with on the last turn.
7. Each player continues in turn until one player reaches 1000.

**Variation/Extension:** Players could add 1 or 10 at the beginning of the year OR Players could start at 0 and spin to add 10 or 100 instead of using number cards. Some students may need to use a hundreds board or number line.

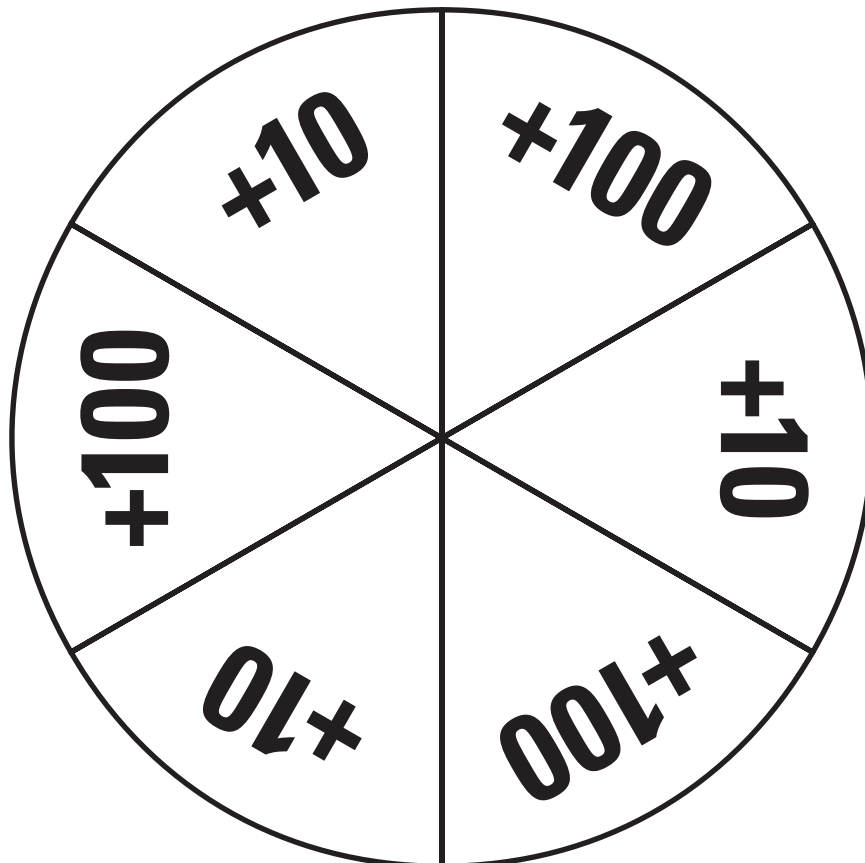

**0****1****2****3****4****5****6****7****8****9****0****1****2****3****4****5****6****7**

8

9

0

1

2

3

4

5

6

7

8

9



# Target 0

**Building Fluency:** subtracting 10 or 100

**Materials:** gameboard, spinner (pencil and paperclip), 3 sets of number cards 0-9, record sheet

**Number of Players:** 2

**Directions:**

1. Place each set of number cards on each stack (Hundreds, Tens, Ones).
2. Player 1 draws a number card from each stack to build a number.
3. Player 1 spins the spinner to determine if he should subtract 10 or 100.
4. Player 1 records his new number on the recording sheet.
5. Player 2 follows steps 2-4.
6. Player 1 spins the spinner to determine if he should subtract 10 or 100 and then subtracts from the number he ended with on the last turn.
7. Each player continues in turn until one player reaches 0.

**Variation/Extension:** Players could subtract 1 or 10 at the beginning of the year OR players could start at 1000 and spin to subtract 10 or 100 instead of using number cards. Some students may need to use a hundreds board or number line.

<b>H</b>	<b>T</b>	<b>O</b>
----------	----------	----------

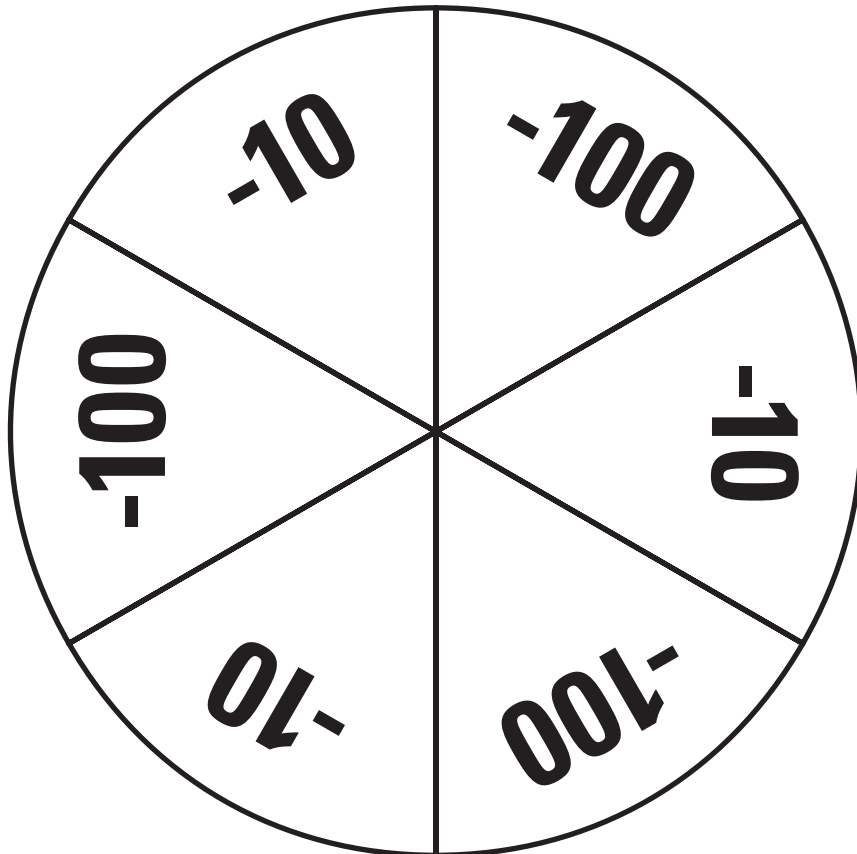

**0****1****2****3****4****5****6****7****8****9****0****1****2****3****4****5****6****7**

**8**

**9**

**0**

**1**

**2**

**3**

**4**

**5**

**6**

**7**

**8**

**9**





# Centimeter Maze

**Building Fluency:** measuring the length of an object

**Materials:** gameboard, die, pencil, ruler

**Number of Players:** 2

**Directions:**

1. Players take turn.
2. Roll the die. Measure that number of centimeters along the path.
3. Mark the measurement.
4. On the next turn, start measuring where you stopped on the previous turn.
5. Play continues until one player has reached the gold.

**Variation/Extension:** Students use an inch ruler or students draw their own paths that are a set length before playing the game. Teacher could laminate or students could create their own gameboard once they understand how to play.

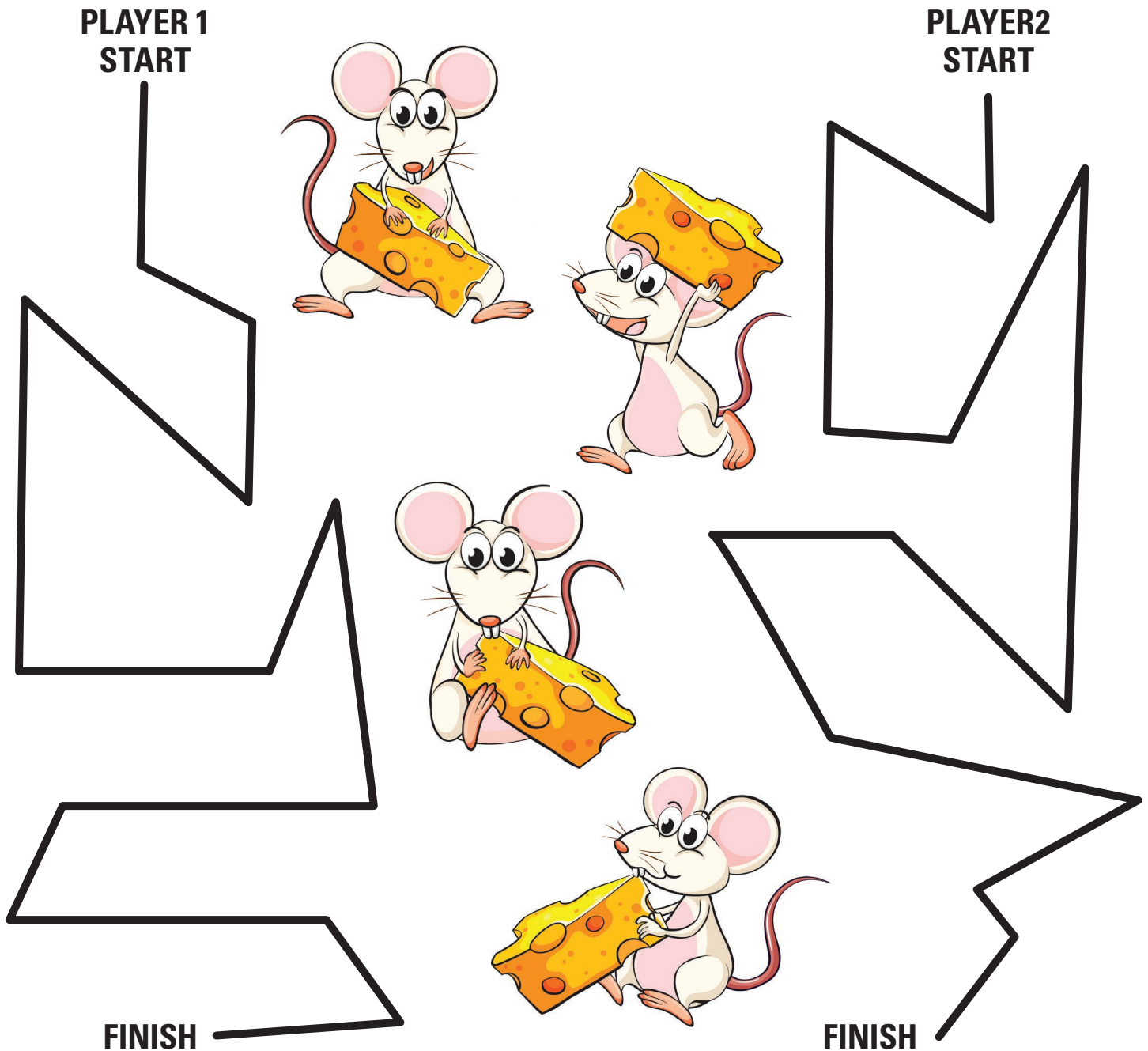



# Time Concentration

**Building Fluency:** telling time with digital and analog clocks

**Materials:** analog and digital clock cards

**Number of Players:** 2-4

**Directions:**

1. Lay the concentration cards face down in an array with five rows and six columns.
2. Players take turns turning over two cards. To be a pair, a digital clock card must be matched with an analog clock card.
3. If the cards match, the player collects the matches, and the next player takes a turn. If the cards do not match, the player turns them face down and the next player takes a turn.
4. Play continues until all matches have been made, and the winner is the player with the most matches.

**Variation/Extension:** Students can play with the cards face up and make matches.

1:45	2:15	3:30
4:25	5:50	6:00
7:10	8:35	9:05
10:20	11:40	12:00

**12:30**

**1:55**

**2:45**

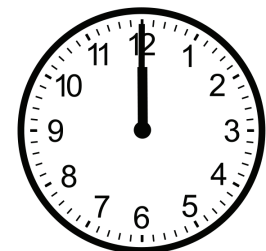
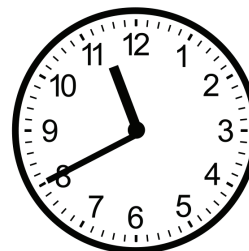
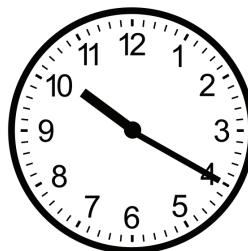
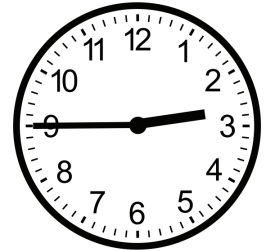
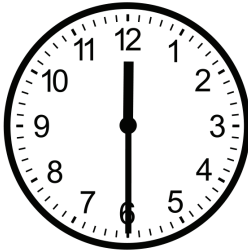
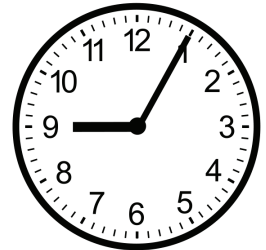
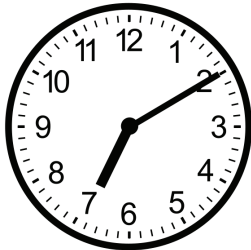
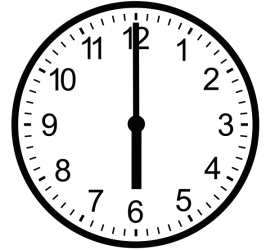
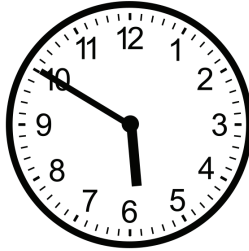
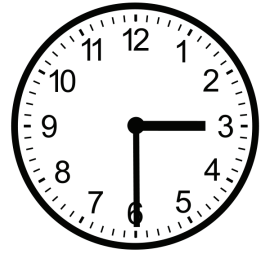
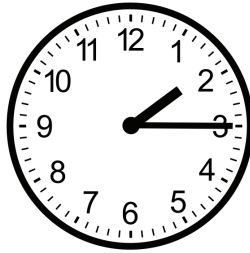
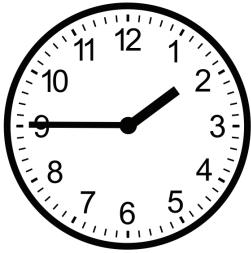

# Geometry Concentration

**Building Fluency:** identifying shapes by attribute







**Materials:** shape and attribute cards

**Number of Players:** 2-4

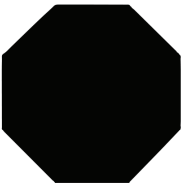
**Directions:**

1. Lay the concentration cards face down in an array with four rows and four columns.
2. Players take turns turning over two cards. To be a pair, a shape card must be matched with an attribute card.
3. If the cards match, the player collects the matches, and the next player takes a turn. If the cards do not match, the player turns them face down and the next player takes a turn.
4. Play continues until all matches have been made, and the winner is the player with the most matches.

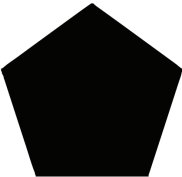
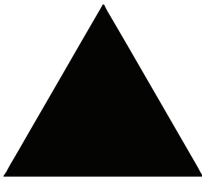
**Variation/Extension:** Students can play with the cards face up and make matches, students can create the shape described on the attribute cards on a geoboard or in their math notebook, or student could make additional cards.

			
			
<b>3 angles and 3 sides</b>	<b>4 equal sides and 4 right angles</b>	<b>2 pairs of parallel equal sides and 4 right angles</b>	<b>4 equal sides/ 0 right angles</b>
<b>exactly 1 pair of parallel sides</b>	<b>5 sides and 5 angles</b>	<b>6 sides and 6 angles</b>	<b>6 faces, 8 vertices, and 12 edges</b>

# Banana Splits

**Building Fluency:** Partitioning rectangles

**Materials:** 2 spinners (pencil and paper clip), gameboard, 4 markers of different colors for each player, paper

**Number of Players:** 2-4

**Directions:**

1. In turn, players spin the two spinners to determine how many rows and columns they should use to partition a rectangle.
2. On paper, the player draws a rectangle and partitions it into the correct number of rows and columns. The player determines how many squares are created in the rectangle.
3. If the total amount is on a banana split, the player puts one of his markers on the space. If the total is already covered, the player loses his turn.
4. The winner is the player that has put all of his counters on the gameboard first.

**Variation/Extension:** Use number cards 1-5 OR players could build arrays (2.OA.4) instead of partitioning.

